

This workshop manual covers the ALBIN AD-2 diesel engine.

The instructions contained herein require certain special tools, which can be purchased from us. The tool kit part number is 49817.

We reserve the right to make modifications in construction.

For this reason the contents of this manual are not binding.

ALBIN MOTOR AB

Service Department

Fig. 1

- 1 Lubricating oil filter
- 2 Feed pump for fuel oil with hand pumping lever
- 3 Lubricating oil dipstick for engine and reverse gear
- 4 Engine oil sump
- 5 Cooling sea-water pump
- 6 Automatic bilge pump
- 7 Hand starting device (conveniently located)
- 8 Fuel oil filter
- 9 Thermostat housing
- 10 Decompression lever
- 11 Injector nozzles
- 12 Oil filler cap for engine and reverse gear
- 13 Exhaust manifold
- 14 Control lever
- 15 Fuel injection pump
- 16 Flywheel, fully enclosed in flywheel housing
- 17 Propeller shaft coupling
- 18 Reduction gear (the engine can be supplied with or without reduction gear)
- 20 Oil filler cap and venting for reduction gear

Fig. 2

- 21 Reverse gear
- 22 Gear lever
- 23 Venting valve for reverse gear
- 24 Inlet silencer with air filter
- 25 Crankcase ventilation
- 26 Inlet manifold
- 27 Generator
- 28 Starter motor

Compression test

Fig. 3

The compression test is as follows:

1. Run the engine until normal temperature is obtained.
2. Remove both injectors.
3. Connect the compression tester to No. 1 cylinder. Turn the engine round with the starter motor until the pointer on the compression tester gives a reading.
4. Vent the recorder - that is, press in the button on the recorder neck - so that the pointer returns to its normal position.

The graph card recording the compression is fed forwards and the instrument is moved to No. 2 cylinder where the same procedure is repeated.

Normally the compression pressure should be 21 kp/cm^2 (300 p.s.i.). If this pressure is not obtained, the reasons may be the following

1. Leaking valves.
2. Worn or carbonized piston rings.
3. Blown cylinder head gasket.

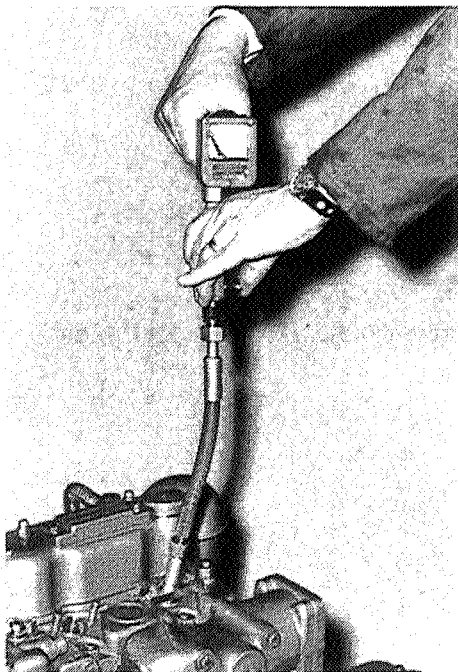
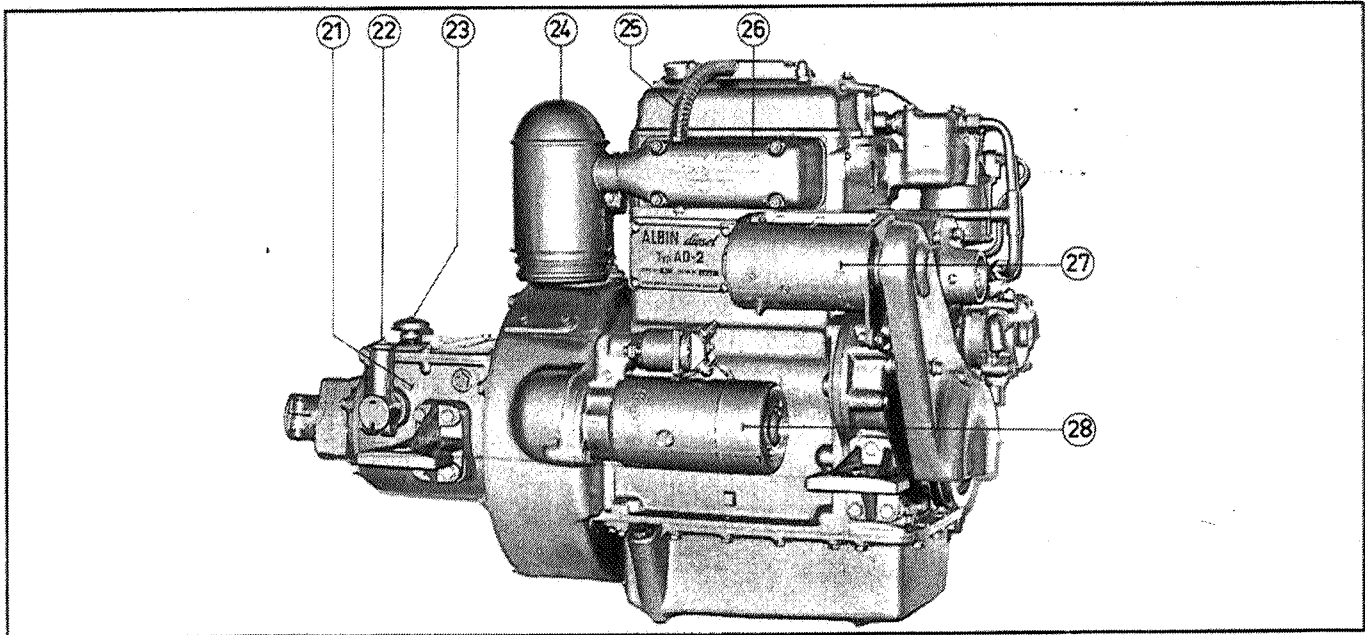
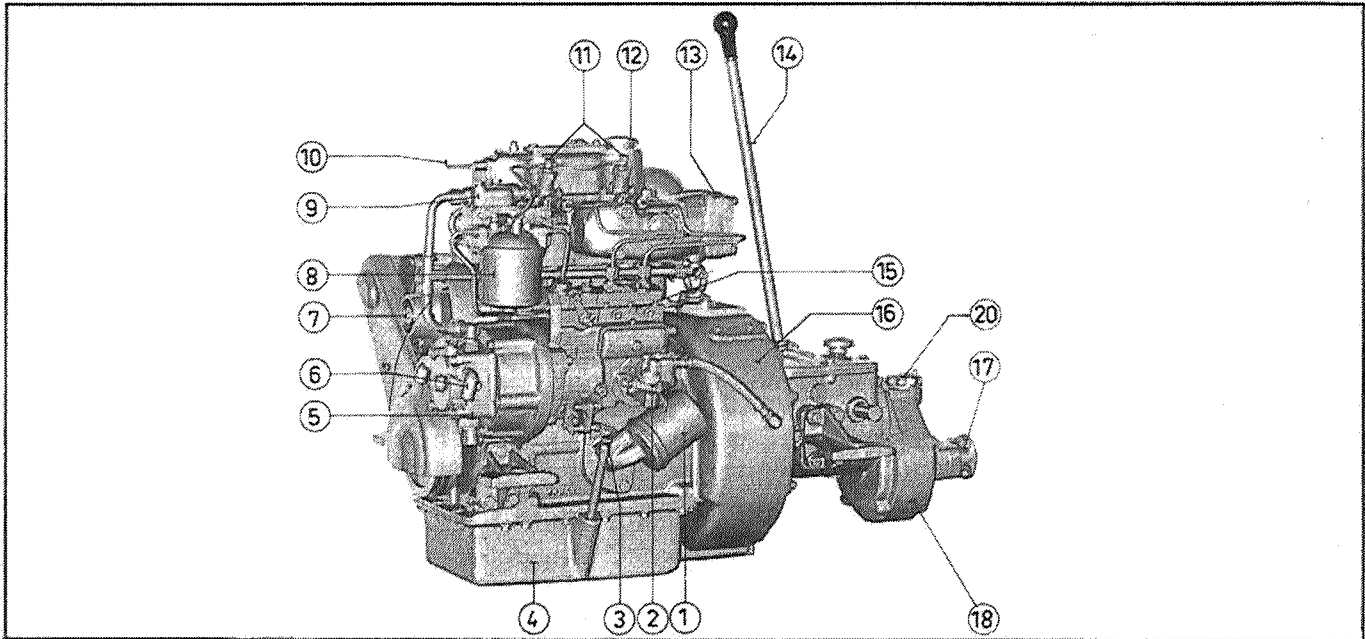

FUEL SYSTEM

Maximum possible cleanliness must be observed when working on a diesel engine fuel system and its equipment.

N.B. Any repair work involving handling the inside of the fuel injection pump may only be carried out by authorized service workshops, which have the proper tools and testing devices at their disposal.

DATA

Combustion system

Combustion system ,.....	Direct injection
Fuel injection pump, Simms	P4717/1
Injectors, Simms	N1172A
Nozzle holders, Simms	HB60S40
Nozzles, Simms	NL123 (4 holes)
Opening pressure, injectors, k ¹ /cm ² (p.s.i.)	165 (2350)
Injection angle (marked on flywheel)	23° B.T.D.C.
Injection quantity, full speed (200 injections at 600 r.p.m.) ..	6.3-6.4 cm ³ (0.384- 0.390 in. ³)
Fuel filter, Simms	FH20
Filter insert, Simms	A18066
Feed pump, AC	Diaphragm type
Feed pump, max. suction lift ..	1.5 m (5 ft.)
Governor	All-speed cen- trifugal gover- nor

Fuel

Specific weight at 15°C (42° F)	0.8-0.9
Viscosity at +20°C (68° F) cst	3.5
Flame point, °C (°F) ...	70 (158)
Lowest fluidity temp. ASTM	
winter, °C (°F)	-30 (-22)
summer, °C (°F)	-20 (-4)
Water content	None
Ash content, max. %	0.001
Sulphur content, max. % ..	0.5
Common salt acc. to Conradson, max.	0.03
Effective calorific value, kcal/kg	10200
Cetane rating, min.	52

Replacing of fuel injection pump only

With a coloured pencil make line-up marks on the injection gear and intermediate gear (Fig. 4).

Remove the injection gear (Fig. 5). Use special tool V4-41992.

Remove the pump (Fig. 6). Special tool for removing of nut on inside of fuel injection pump, V4-70356.

When fitting the pump, check to make sure that the marking, X/-X is lined-up properly (Fig. 7).

Fitting fuel injection pump on engine which has been completely removed

Prise the engine (Fig. 8) in its direction of rotation to position shown in Fig. 9.

No. 1 cylinder piston at top compression stroke. Indicating pointer points to T.D.C. (Fig. 9).

Check that line-up marks coincide (Fig. 10). Injection gear 1. against intermediate gear 1 - 1. Intermediate gear 2. against crankshaft gear 2 - 2. Intermediate gear 0. against camshaft gear 0 - 0.

Adjust location of fuel injection pump to X/-X (Fig. 7).

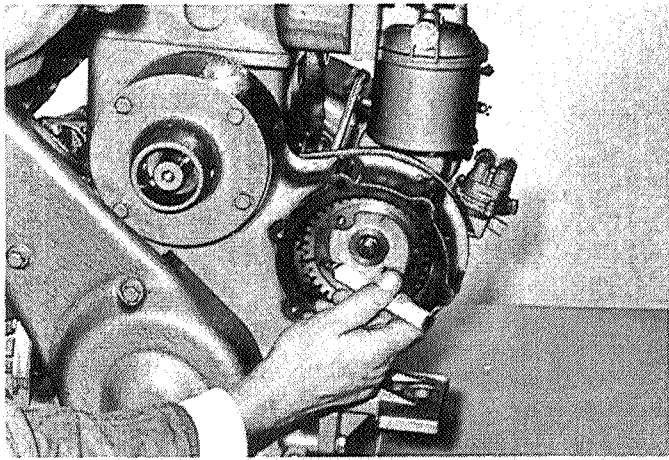

4

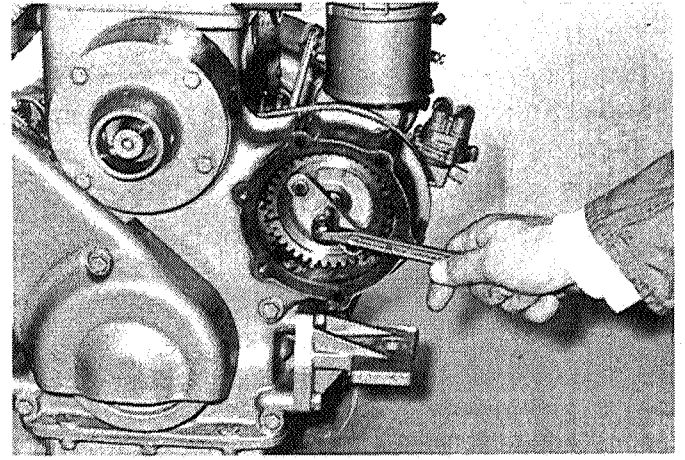

5

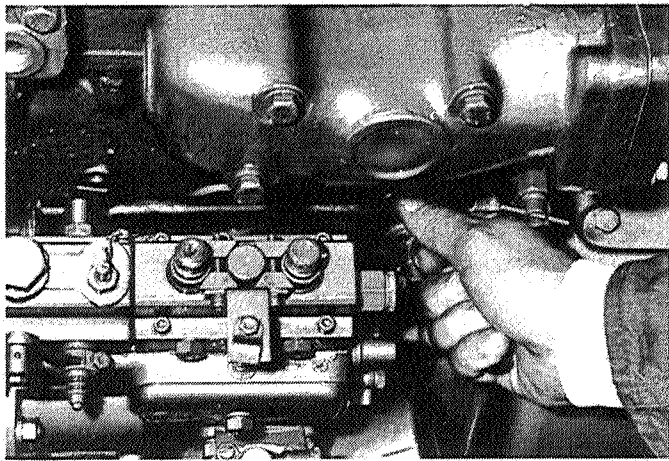

6

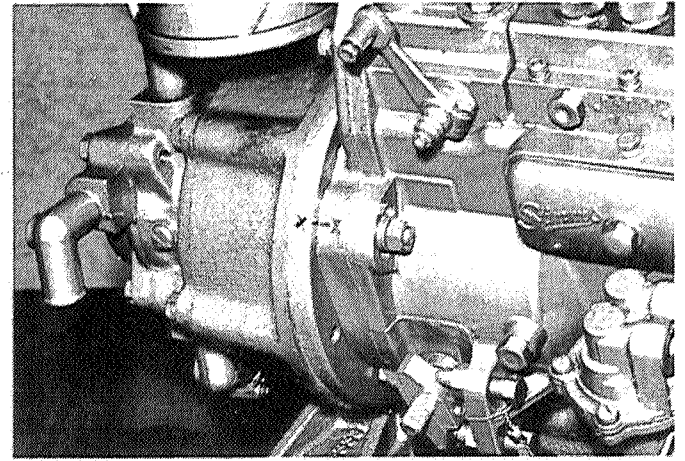

7

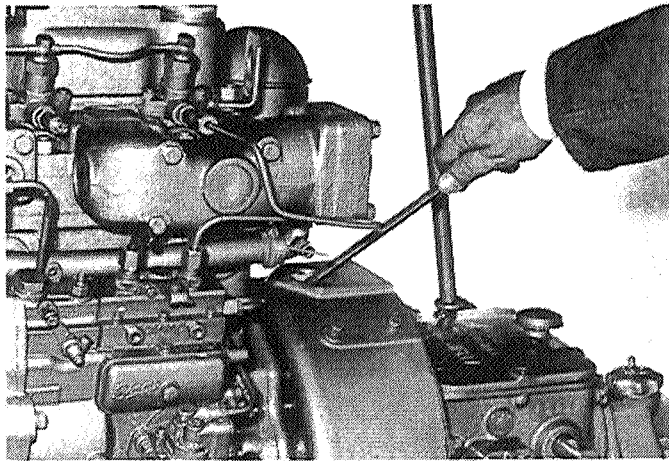

8

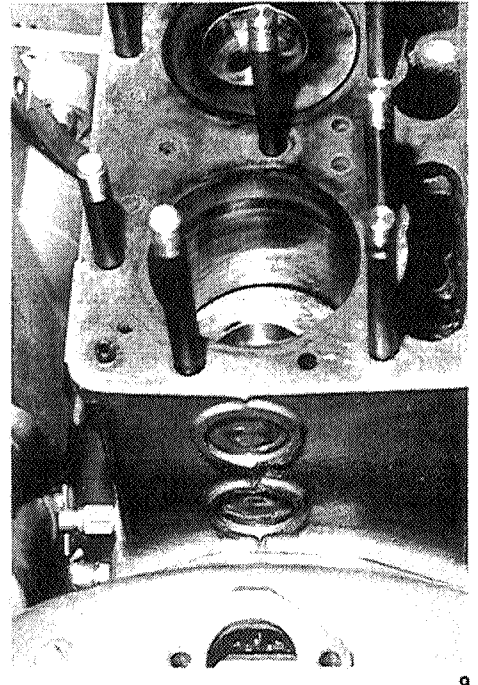

9

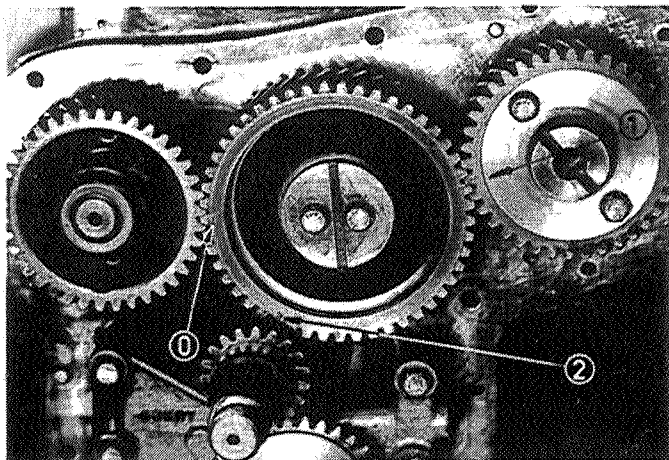

10

6.

Checking correct setting of fuel injection pump

Remove the thrust valve bolting for No. 1 cylinder (Fig. 11).

Remove the thrust valve and spring (Fig. 12).

Remove the drip pipe (Fig 13). Set the governor lever to full throttle. Special tool V4-41992.

Prise the motor in its direction of rotation (Fig. 14) while pumping up the fuel by hand. Injection should begin with the indication pointer pointing to the X-mark on the flywheel. In other words, when fuel stops dripping out of the pipe.

When re-fitting the thrust valve bolting, tighten with a torque wrench (Fig.15).

Required torque is 4.6 kpm (33 lb.ft.).

Setting the injector

Remove the upper part of the injector (Fig. 16). Special tool V3-41993.

Test the injection pressure with the nozzle tester (Fig. 17). The opening pressure for the injector should be 165 kp/cm² (2350 p.s.i.).

If the opening pressure is not correct, adjust it. Screwing in the adjusting screw - higher pressure. Screwing out - lower pressure (Fig. 18).

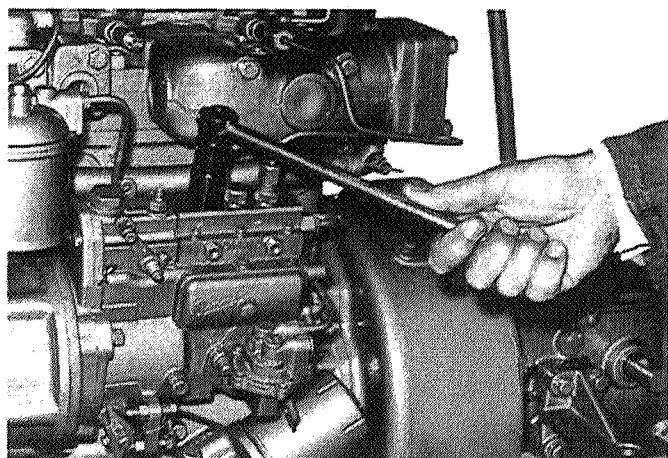

11

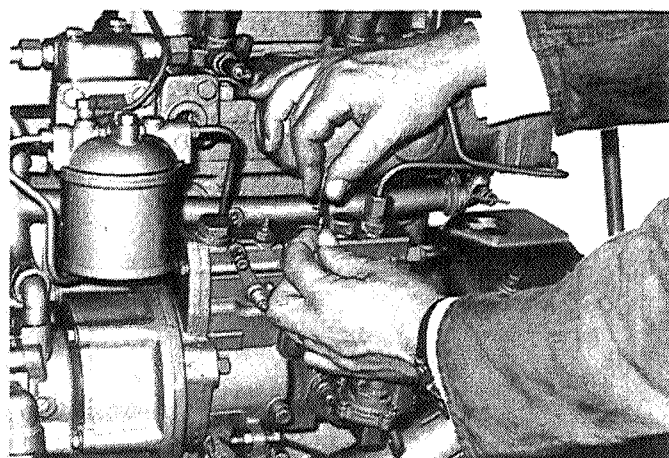

12

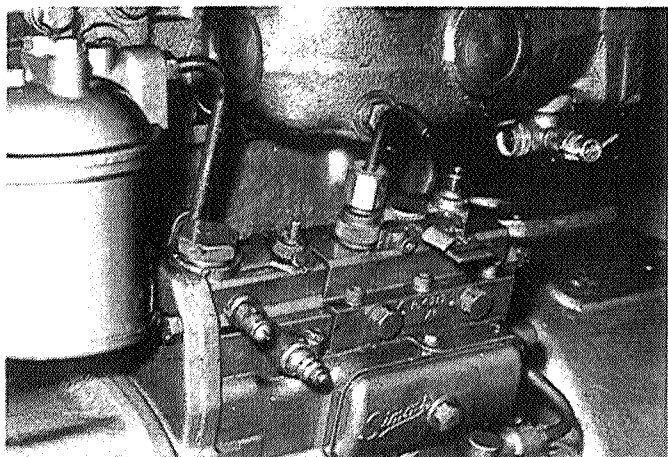

13

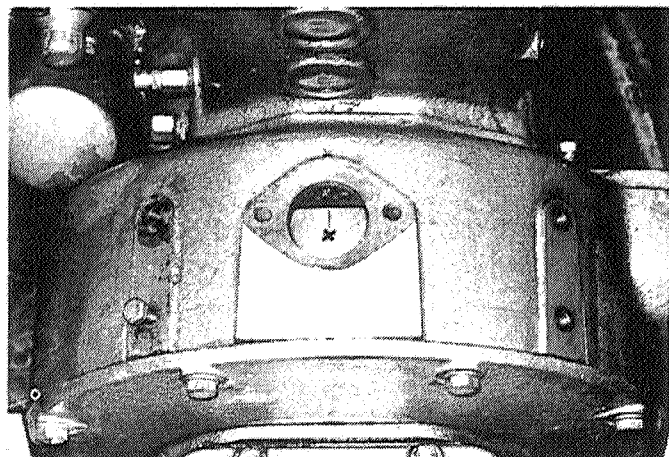

14

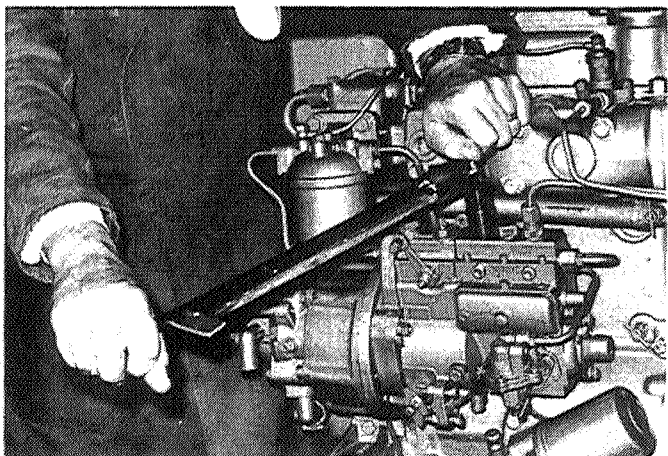

15

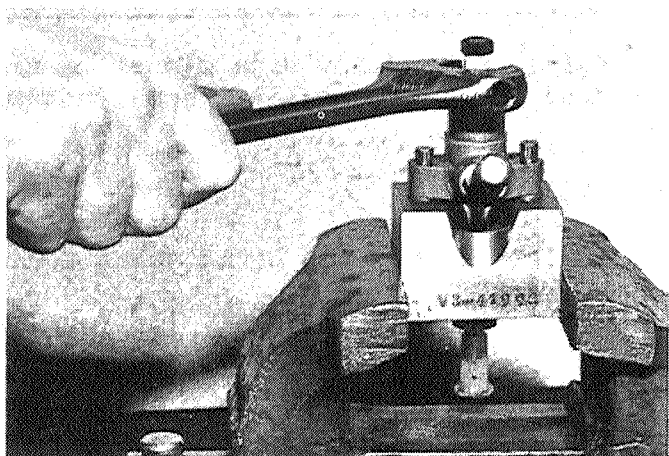

16

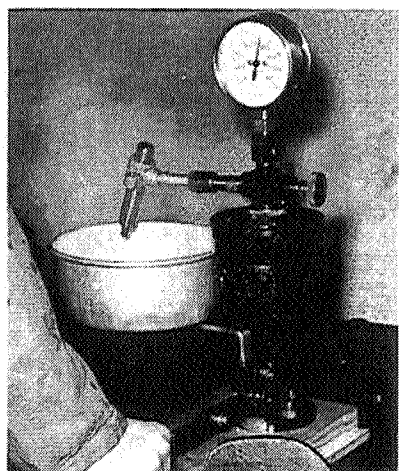

17

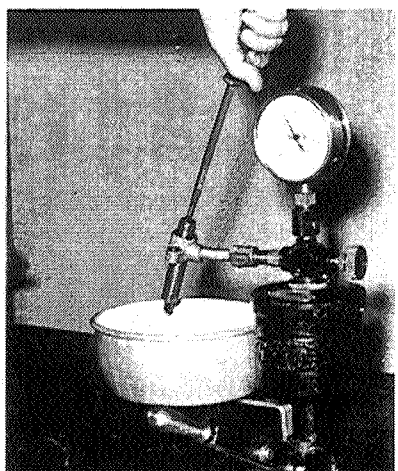

18

8.

Replacing fuel filter insert

Remove the top screw (Fig. 19).

Replace the filter with a new one (Fig. 20).

Bleeding the fuel system

Release the fuel filter bleed screw (Fig. 21). Pump with the feed pump manual pump lever until fuel free from air bubbles flows out.

Release the fuel injection pump venting screw (Fig. 22). Pump until all air is removed.

Filling the fuel injection pump with oil

Fill with oil until it runs out of the level plug hole A (Fig. 23). Use the same oil quality as in the engine.

COOLING SYSTEM

1. The thermostat can be replaced after the cap has been removed (Fig. 24).

Opening temperature 77°C (170°F).

Fully open thermostat 86.5°C (188°F).

Thermostat for tropical waters:

Opening temperature 66°C (150°F)

Fully open thermostat 77°C (170°F).

2. The impeller blades of the cooling pumps are removed by pulling in the direction of the arrow (Fig. 25).

Pump capacity at full speed 15 l/min. (26 Imp.pints = 31.5 US pints)

Pump capacity at idling 4 l/min. (7 Imp.pints = 8.5 US pints)

3. When removing the cooling pump sealing ring use Drift V4-41995 (Fig. 26).

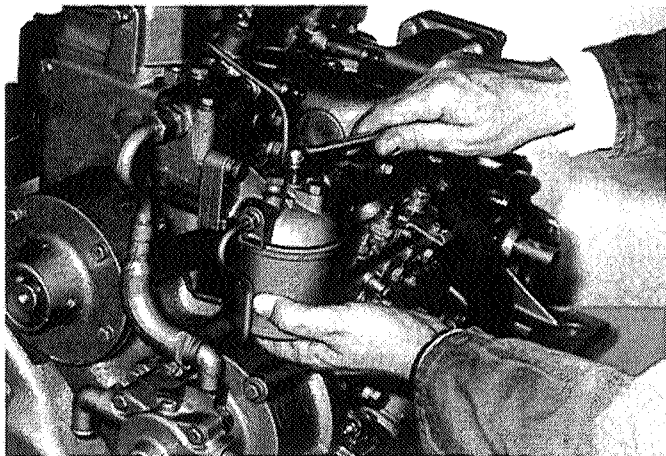

19

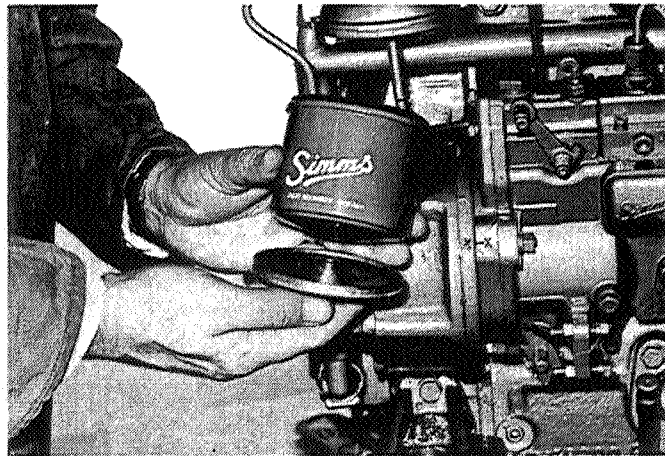

20

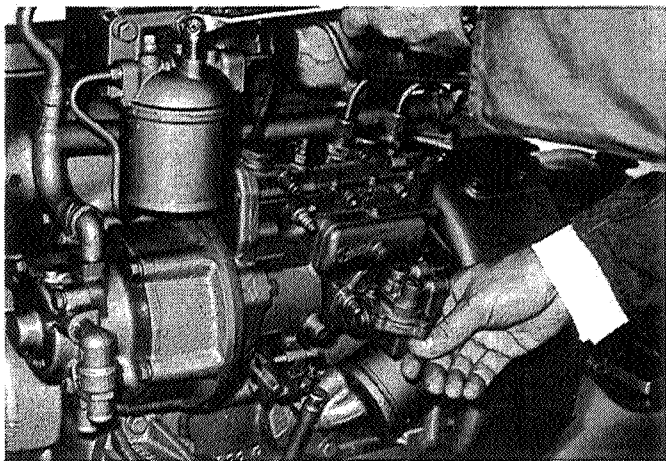

21

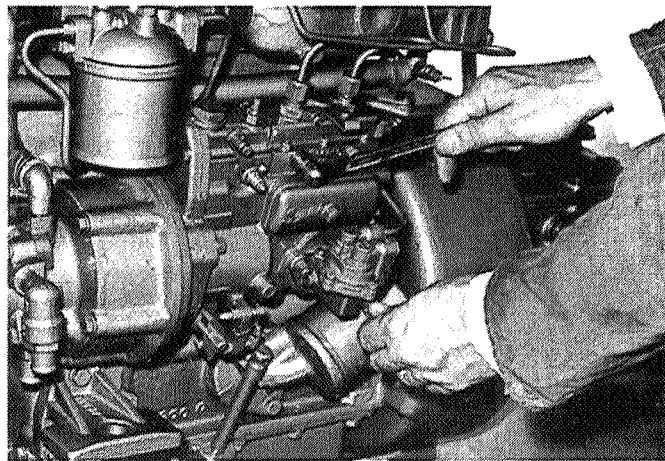

22

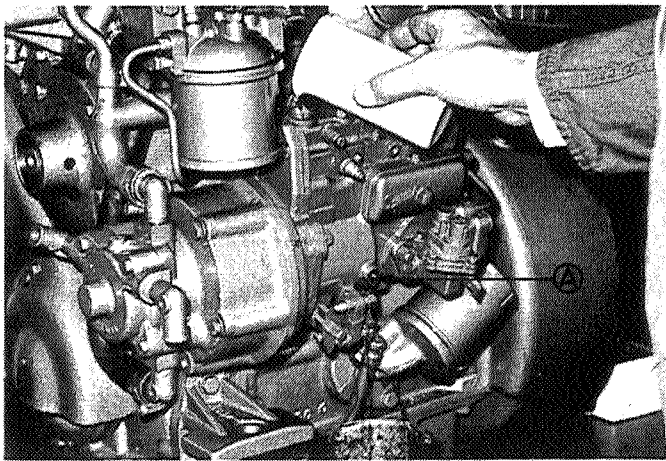

23

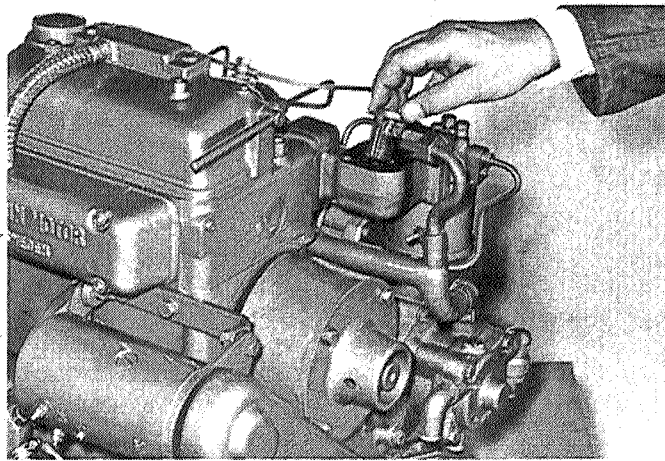

24

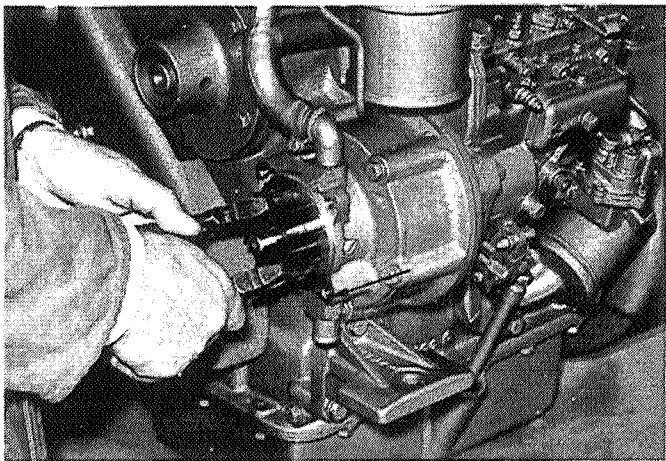

25

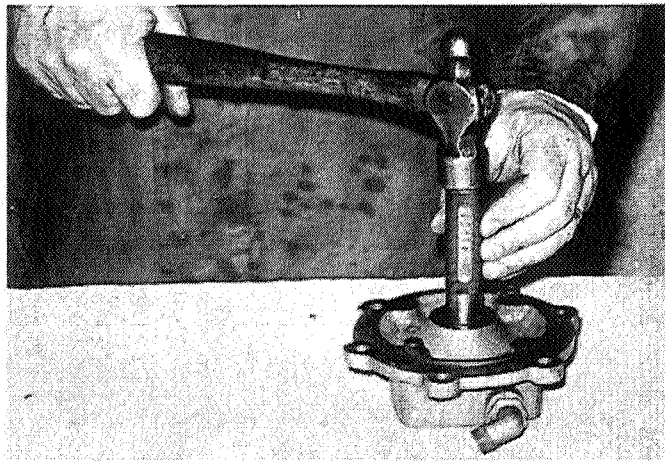

26

COOLING SYSTEM (cont.)

4. Note the location of the pin as flange for the impeller (Fig. 27).

For engines with indirect cooling system

5. The radiator insert is removed by releasing the centre bolt (Fig. 28).
6. Pull out the radiator insert (Fig. 29).
7. Clean the insert before re-fitting (Fig. 30).
8. Change the sealing rings (Fig. 31).

LUBRICATING SYSTEM

1. Oil filter overflow valve (Fig. 32). This opens when the oil filter is blocked.
2. Removing the lubricating oil filter (Fig. 33). The oil filter should be changed after every 300 hours of operation. The filter cannot be cleaned but must be replaced.
3. Oil the lubricating oil filter sealing with engine oil before fitting (Fig. 34).

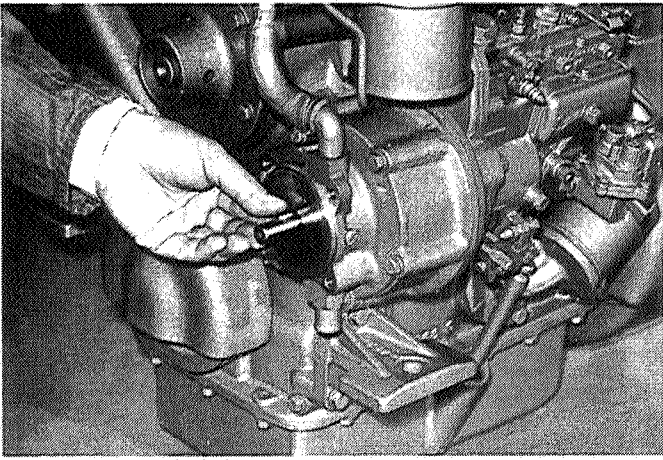

27

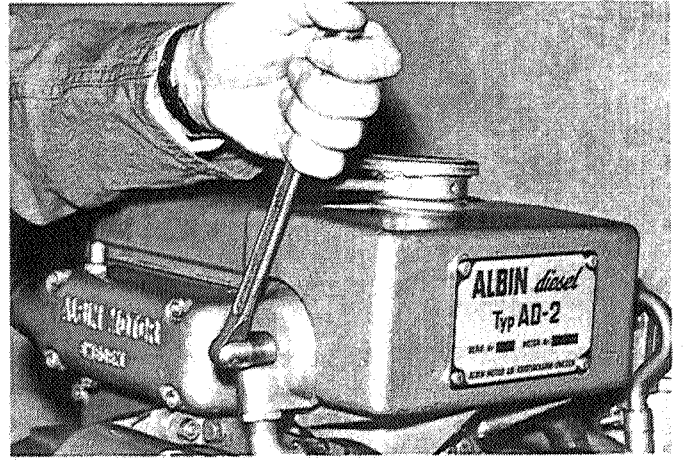

28

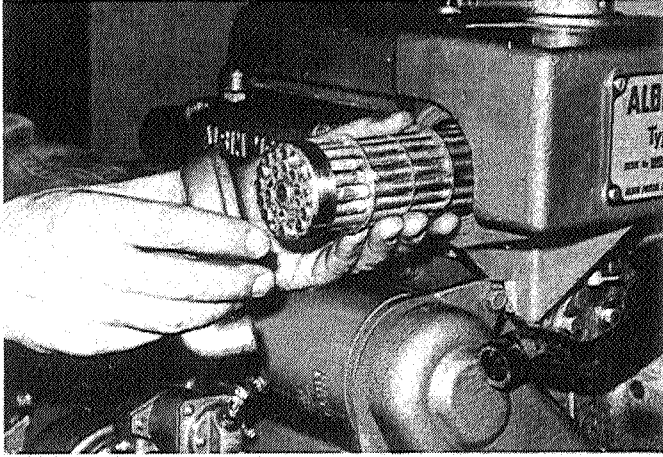

29

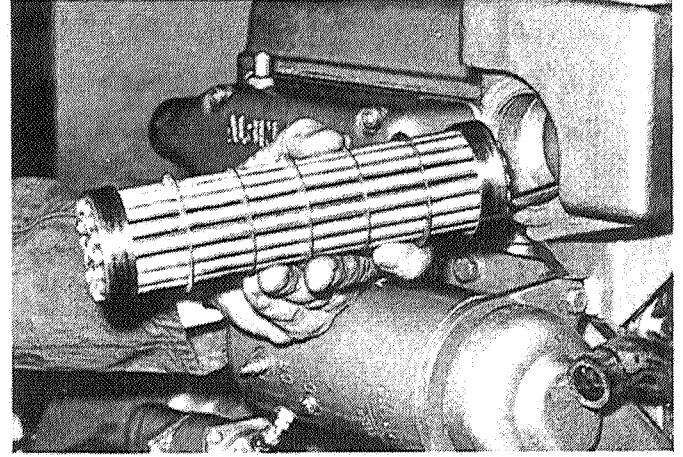

30

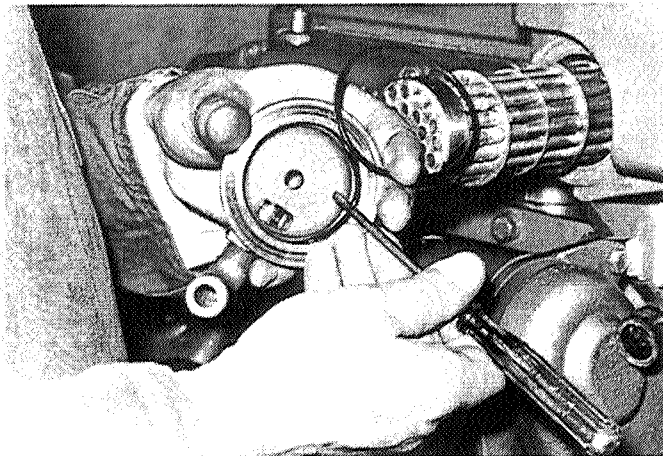

31

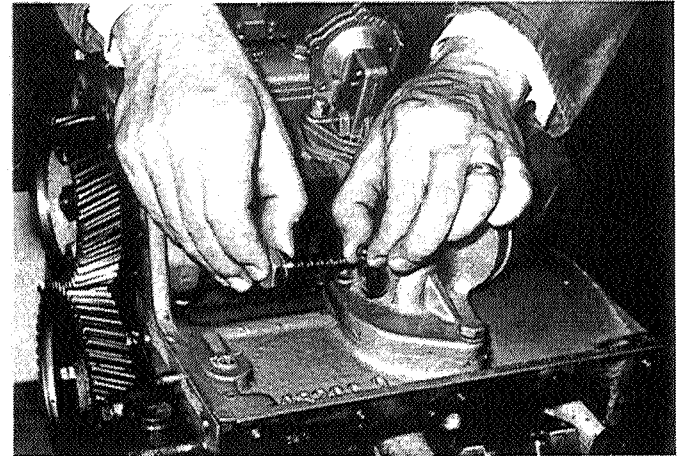

32

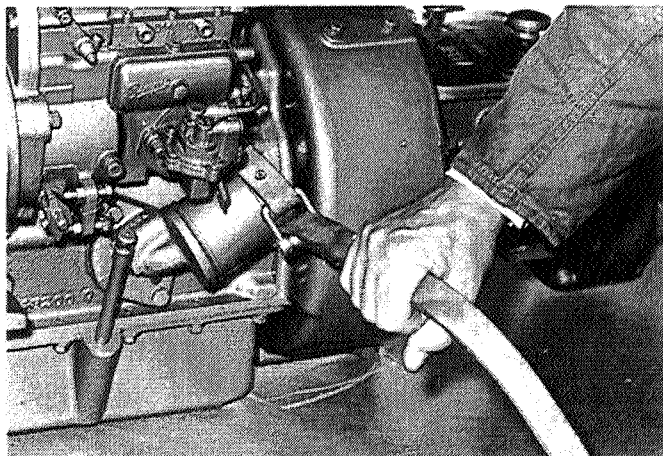

33

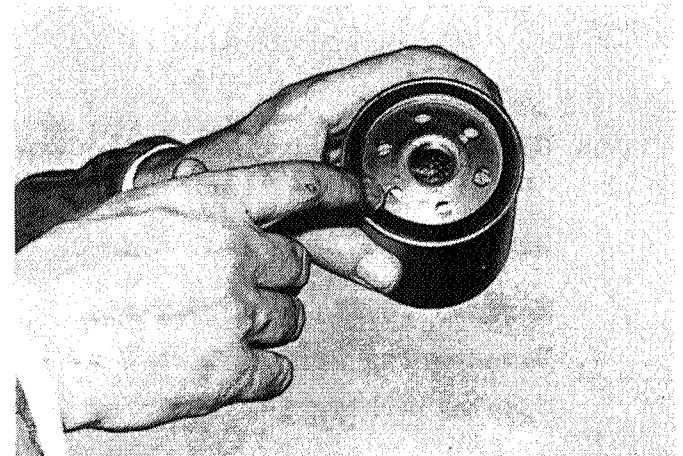

34

LUBRICATING SYSTEM (cont.)

4. Fitting of lubricating oil filter (Fig. 35).
Tighten the filter firmly by hand.
5. The lubricating oil strainer is removed by unhooking the lock wire (Fig. 36).
6. Replace the sealing ring when the entire oil strainer has been removed (Fig. 37).
7. Lubricating oil pump oil relief valve (Fig. 38).
8. Lubricating oil pump with cover removed (Fig. 39).
Oil pressure with hot engine 2-3 kp/cm² (29-43 p.s.i.).
Minimum pressure, 0.5 kp/cm² (7 p.s.i.) at idling.

Air filter

Removing of air filter for cleaning (Fig. 40).

Should be washed in white spirit and blown clean with compressed air.

Cylinder block

1. Measuring of cylinder bore with help of dial indicator (Fig. 41).

Diameter $90^{+0.000}_{+0.022}$ mm ($3.543^{+0.000}_{+0.009}$ inches)

Maximum wear 0.2 mm (0.008").

2. Removing and fitting of camshaft bushes (Fig. 42).

Special tool for bush ϕ 44: Drift V4-41983

Special tool for bush ϕ 32: Drift V4-41984

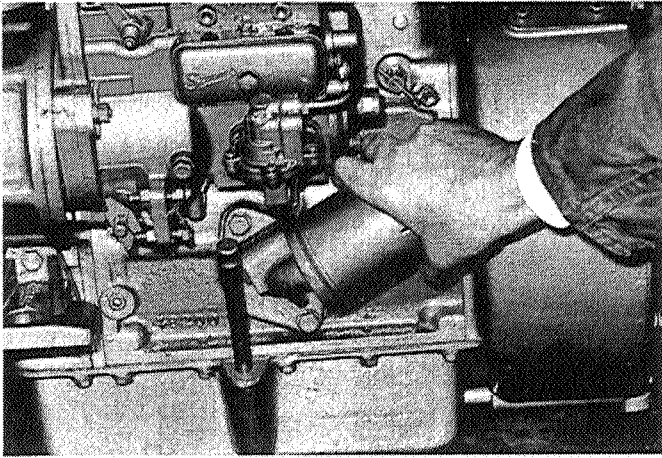

35

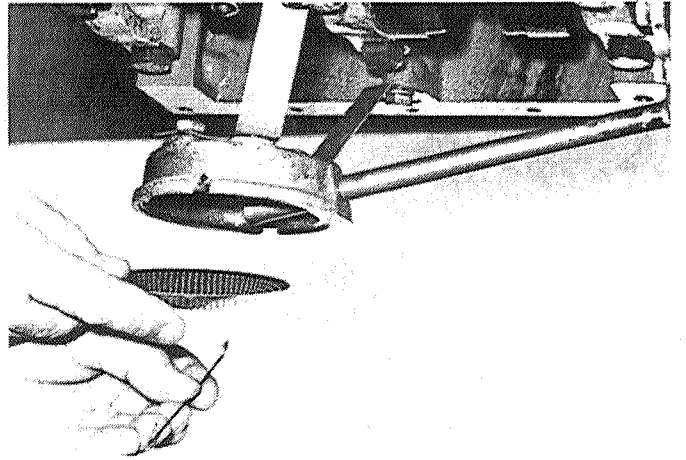

36

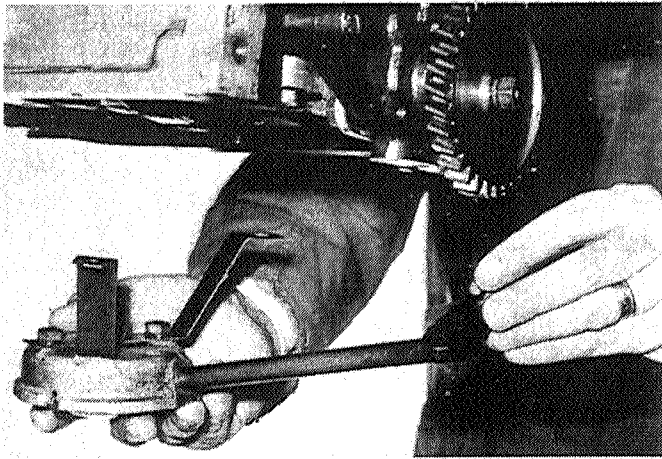

37

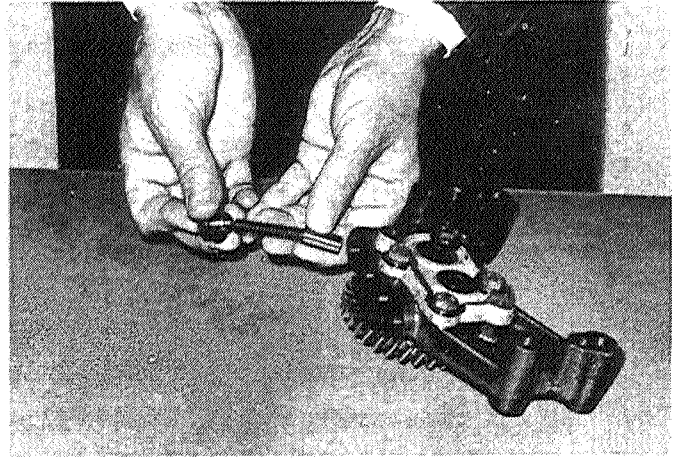

38

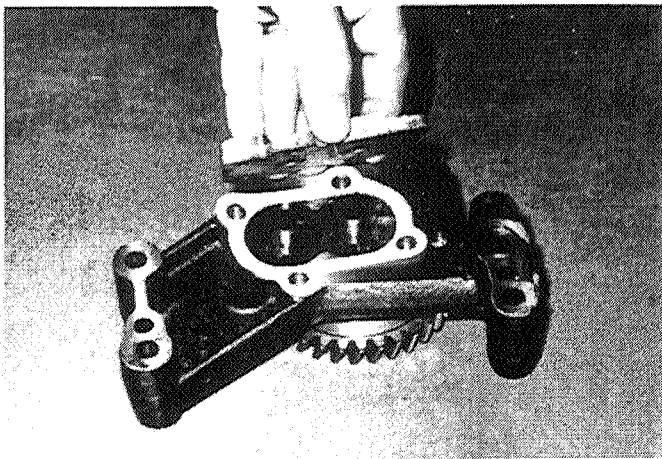

39

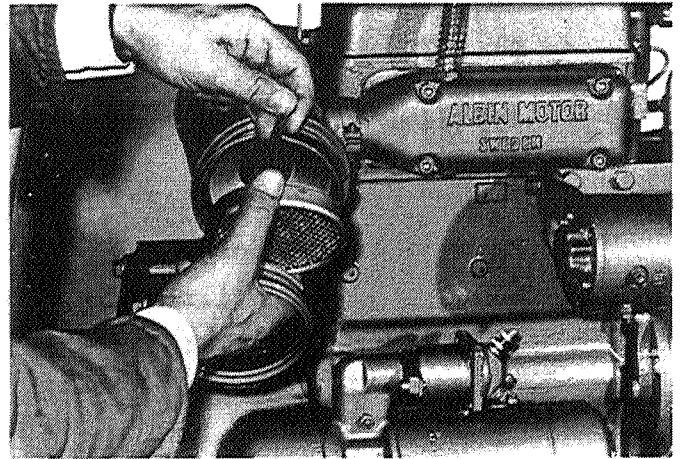

40

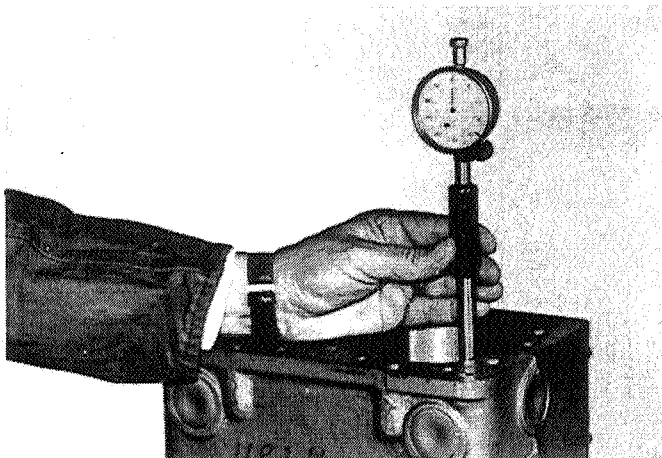

41

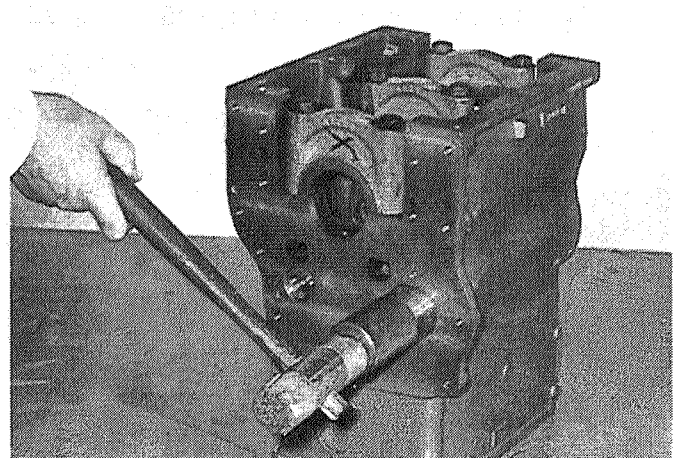

42

Cylinder block (cont.)

3. Fit the main bearing caps according to the marking 1-2-3 (Fig. 43).
4. Tighten the main bearing bolts with torque wrench (Fig. 44).

Required tightening torque is 10 kpm (72 lb.ft.).

Check axial play of crankshaft, which should be 0.1 - 0.4 mm (0.0039 - 0.0157").

1. Removing camshaft gear (Fig. 45).
Special tool, puller V3-41991.
2. Removing and fitting of bush for intermediate gear (Fig. 46).
Special tool, Drift V4-41989.
3. Fitting of sealing ring in cover for gear wheel case (Fig. 47).
Special tool, Drift V4-41997.

Cylinder head

1. Removing of valve guide (Fig. 48).
Special tool, Drift V4-41988.
2. Fitting of valve guide (Fig. 49).
Special tool, V4-41012.
Valve clearance:

Inlet valve, mm (in.)	0.05 (0.002).
Exhaust valve, mm (in.)	0.05 (0.002).
3. Fitting of valve seat (Fig. 50).
Special tool, Drift V4-41625.
The cylinder head is heated in boiling water.

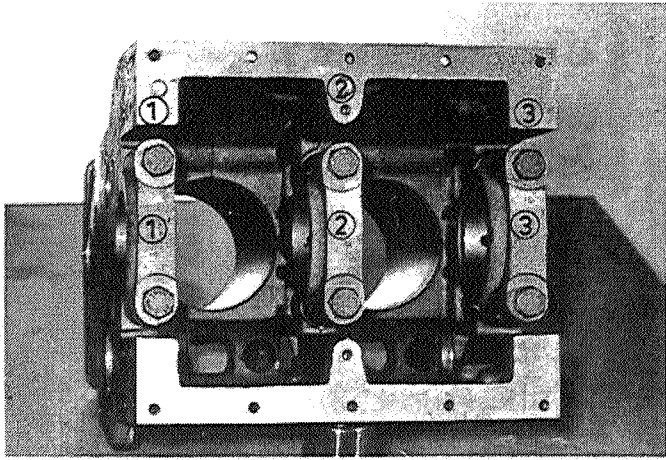

43

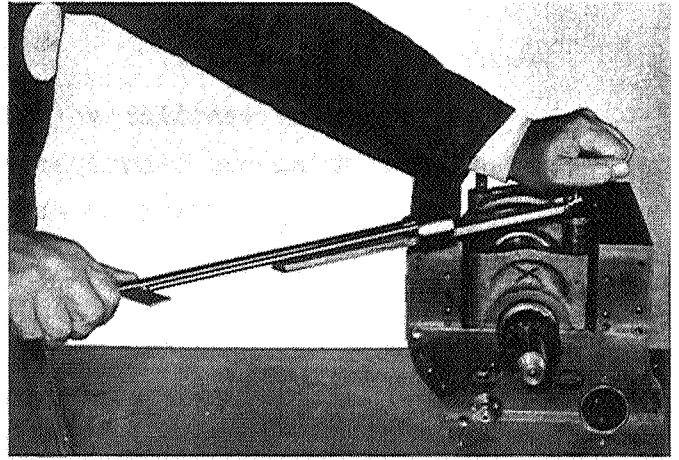

44

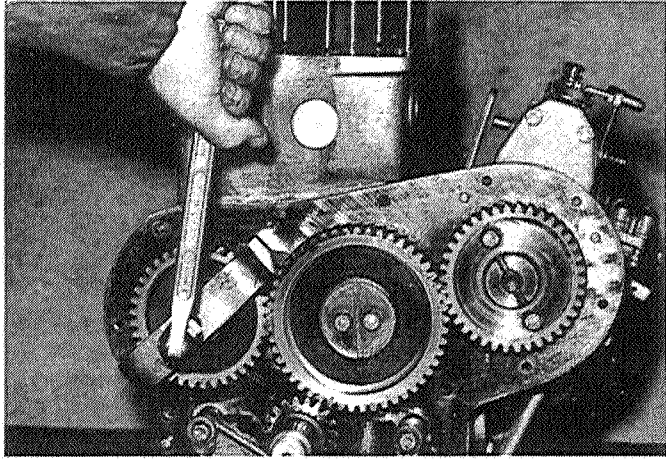

45

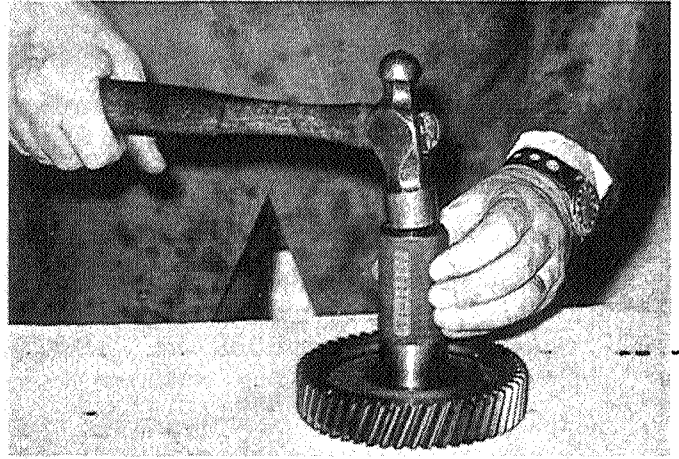

46



47

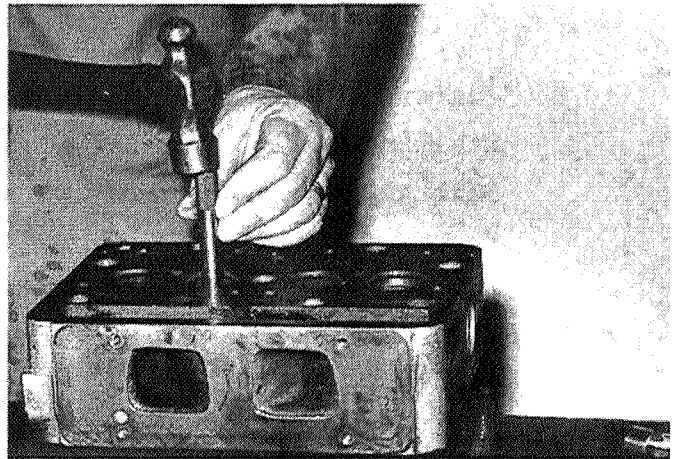

48



49

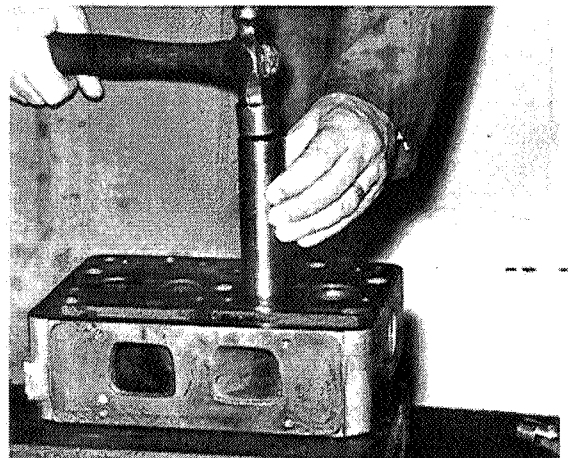

50

Cylinder head (cont.)

4. Grinding of valve seat (Fig. 51).

Finish-grinding with valve paste should be carried out.

Special tools: Guide pin for valve grinding, inlet, V4-42010.
Guide pin for valve grinding, exhaust, V4-42011.

Valve seat and valve angle.

Inlet valve	30°
Exhaust valve	30°

Valve diameter

Inlet valve	36 mm (1.42")
Exhaust valve	32 mm (1.26")

5. Removing and fitting of rocker arm bush (Fig. 52).

Special tool, Drift V4-41987.

6. When fitting cylinder head, tighten the nuts with a torque wrench (Fig. 53).
Required tightening torque, 10 kpm (72 lb.ft.).

7. Adjusting valve clearance (Fig. 54).

Valve clearance, cold engine

Inlet valve	0.3 mm (0.0118")
Exhaust valve	0.3 mm (0.0118")

Inlet valve

Opens, before T.D.C.	18°
Closes, after B.D.C.	52°

Exhaust valve

Opens, before B.D.C.	54°
Closes, after T.D.C.	16°

8. Adjusting decompression device (Fig. 55).

Set engine so that both exhaust valves are closed.

Screw in the adjusting screws towards the rocker arms.

Screw them down a further 1/2 to 3/4 flat.

Lock the screws with the locknuts.

Crankshaft

1. Measuring of main bearing pins with help of micrometer (Fig. 56).

Diameter, standard 57 $\begin{matrix} +0.112 \\ +0.099 \end{matrix}$ mm (2.244 $\begin{matrix} +0.0044" \\ +0.0039" \end{matrix}$)

Diameter, 1st undersize 56.7 $\begin{matrix} +0.112 \\ +0.099 \end{matrix}$ mm (2.232 $\begin{matrix} +0.0044" \\ +0.0039" \end{matrix}$)

Diameter, 2nd undersize 56.4 $\begin{matrix} +0.112 \\ +0.099 \end{matrix}$ mm (2.220 $\begin{matrix} +0.0044" \\ +0.0039" \end{matrix}$)

Max. permissible out-of-round 0.06 mm (0.0024")

Max. permissible taper 0.05 mm (0.0020")

2. Measuring of big-end bearing pins with help of micrometer (Fig. 57).

Diameter, standard 57 $\begin{matrix} +0.112 \\ +0.099 \end{matrix}$ mm (2.244 $\begin{matrix} +0.0044" \\ +0.0039" \end{matrix}$)

Diameter, 1st undersize 56.7 $\begin{matrix} +0.112 \\ +0.099 \end{matrix}$ mm (2.232 $\begin{matrix} +0.0044" \\ +0.0039" \end{matrix}$)

Diameter, 2nd undersize 56.4 $\begin{matrix} +0.112 \\ +0.099 \end{matrix}$ mm (2.220 $\begin{matrix} +0.0044" \\ +0.0039" \end{matrix}$)

Max. permissible out-of-round 0.06 mm (0.0024")

Max. permissible taper 0.05 mm (0.0020")

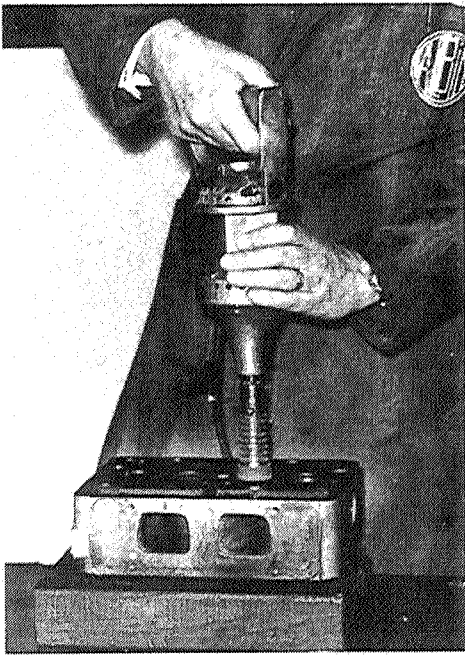

51

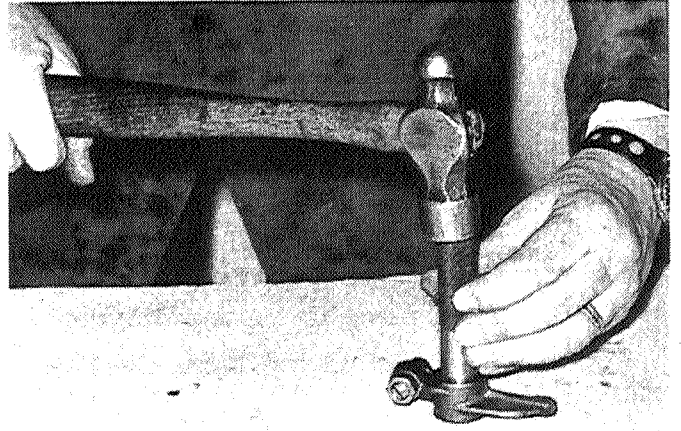

52

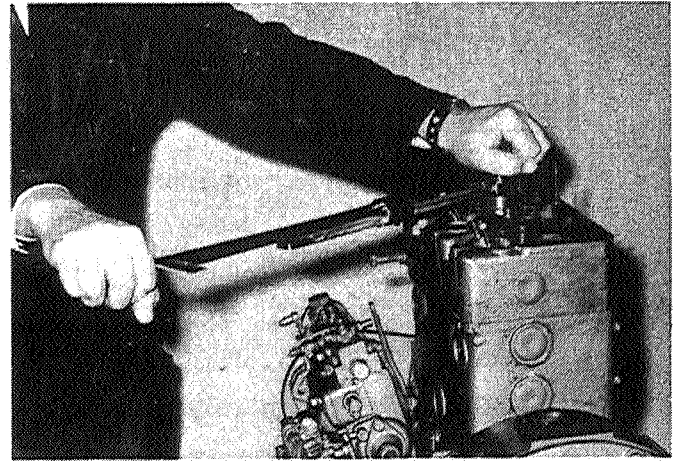

53

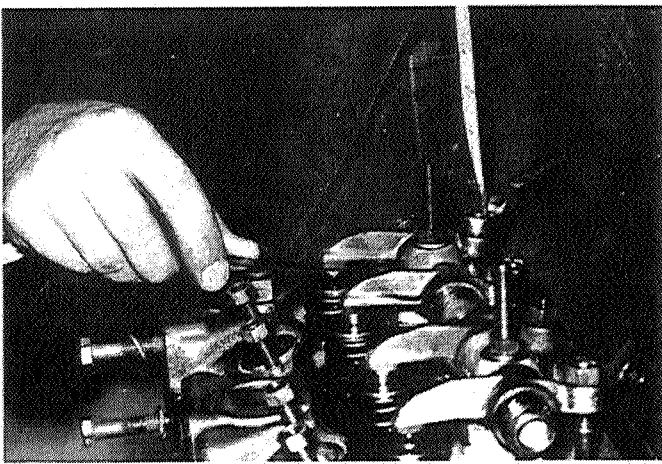

54

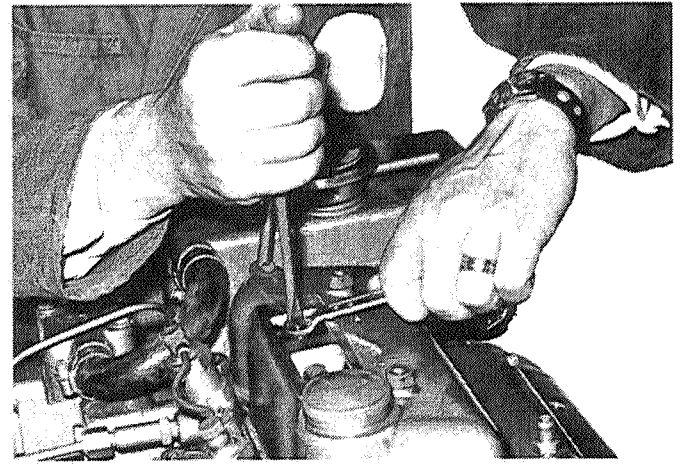

55

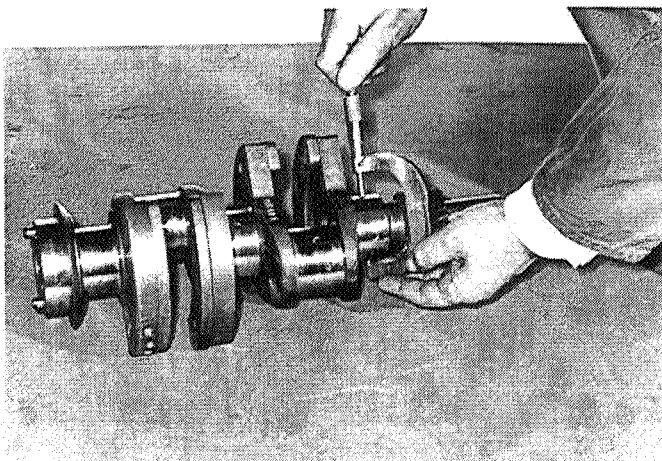

56

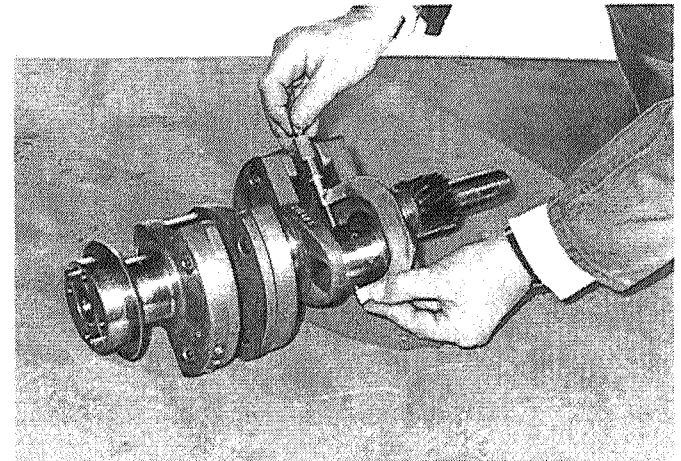

57

Crankshaft (cont.)

3. Fitting of crankshaft gear (Fig. 58).
Special tool, Drift 4V-41990

Piston and connecting rod

1. Measuring of connecting rod big end with help of dial indicator (Fig. 59).
Diameter $60.8 \begin{matrix} +0.033 \\ +0.046 \end{matrix}$ mm ($2.394 \begin{matrix} +0.0013'' \\ +0.0018'' \end{matrix}$)
2. For removing and fitting of gudgeon pin bush use Drift V4-41985 (Fig. 60).
3. Drift for removing gudgeon pin, V4-41986 (Fig. 61).
4. The piston rings are removed and fitted with ordinary piston ring pliers (Fig. 62).

Piston ring gap

Compression ring No. 1	0.356/0.483 mm (0.0140/0.0190")
Compression rings Nos.2 and 3	0.279/0.406 mm (0.0109/0.0159")
Oil scraper rings Nos.1 and 2	0.279/0.406 mm (0.0109/0.0159")

Piston ring clearance - height.

Compression ring No. 1	0.114/0.063 mm (0.004-0.002")
Compression rings Nos.2 and 3	0.089/0.038 mm (0.0035-0.0015")
Oil scraper rings Nos.1 and 2	0.089/0.038 mm (0.0035-0.0015")

5. Heat the piston on a cooking plate before fitting the connecting rod (Fig. 63).
6. Fitting of connecting rod and piston (Fig. 64).

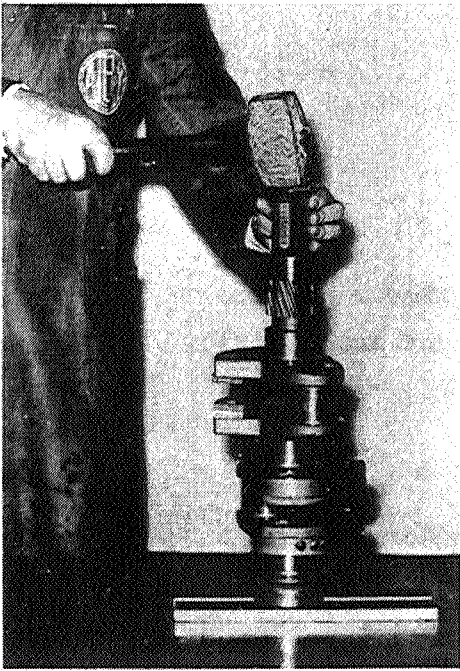

58

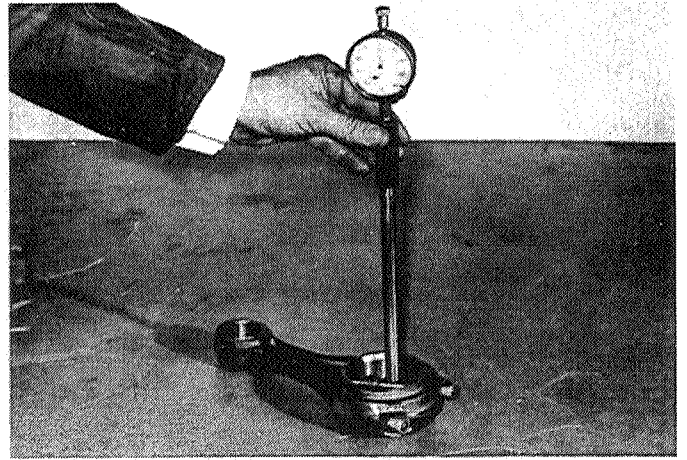

59

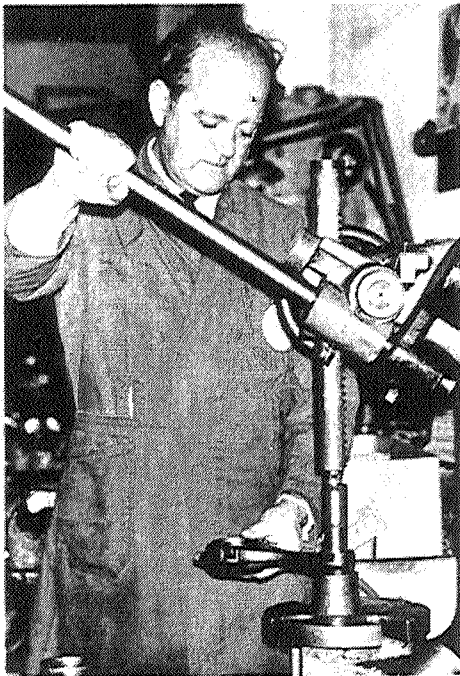

60

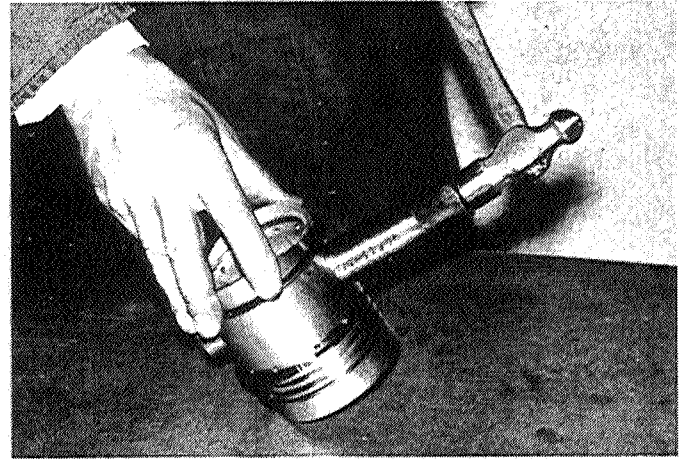

61

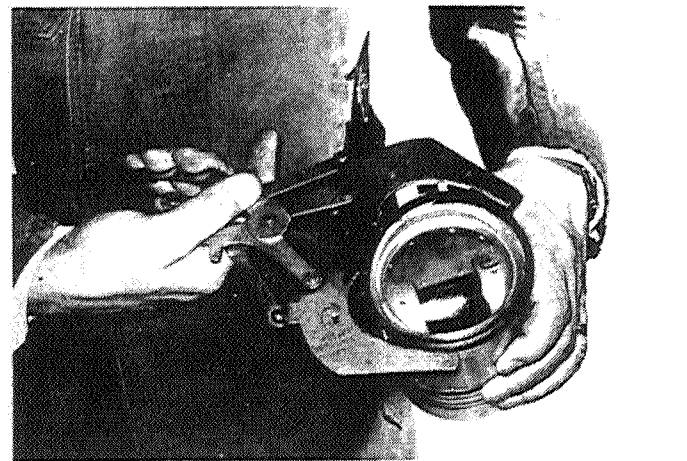

62

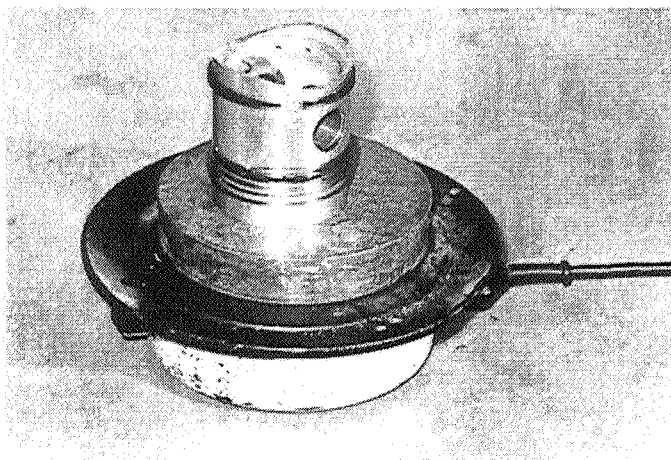

63

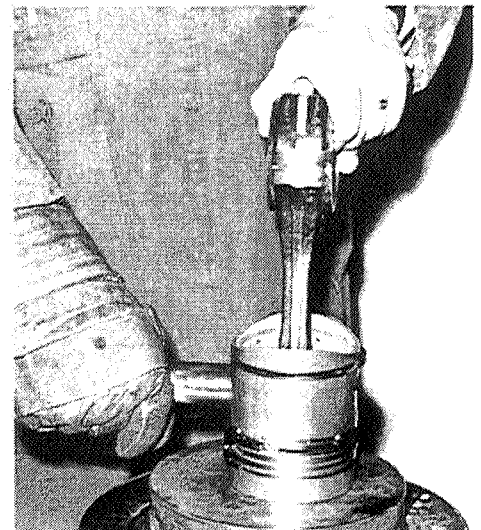

64

20

Piston and connecting rod (cont.)

7. When fitting the connecting rod and piston in the cylinder block, make sure that the piston is fitted with the marking - Front - facing the front end of the engine (Fig. 65).

Max. piston clearance, 0.12 mm (0.48").

1. When removing the flywheel, the two threaded holes - thread 5/16 UNC - can be used for the snap bolt (Fig. 66).
2. When fitting the flywheel, tighten the bolts with a torque wrench (Fig. 67).
Required tightening torque 2.6 kpm (19 lb.ft.).

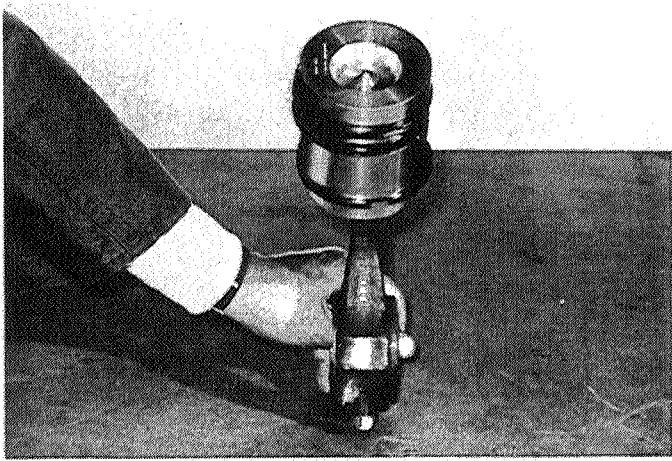

65

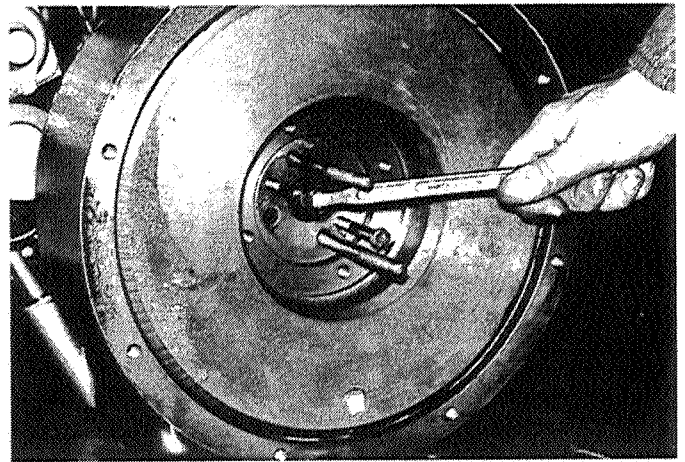

66

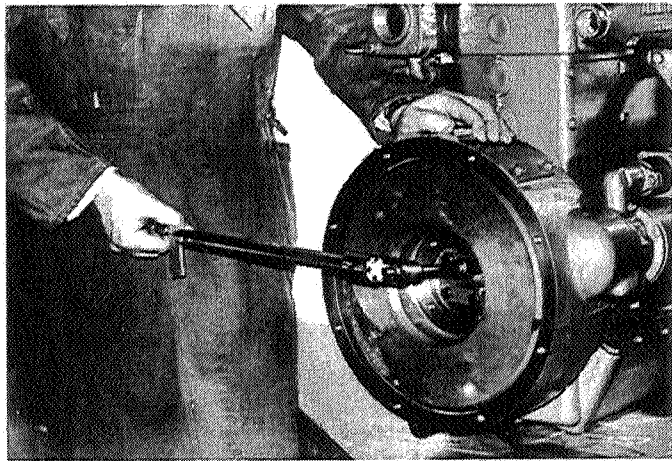

67

x

72.

Reverse gear and reduction gear

Removing and fitting of reverse gear and reduction gear for inspection and repairs.

1. Release the bolts holding the gear housing. Remove the housing with the output shaft and gear wheel (Fig. 68).
2. Remove the locknut on the reverse gear shaft (Fig. 69).
3. Remove the lock washer (Fig. 70).
4. When removing the lever for the brake band, the bolt holding the lever must be knocked out (Fig. 71).
5. Remove the lever (Fig. 72).
6. Release the bolts in the control fork so that the control shafts can be removed (Fig. 73).
7. Remove the control shafts (Fig. 74).
8. Remove the control fork (Fig. 75).

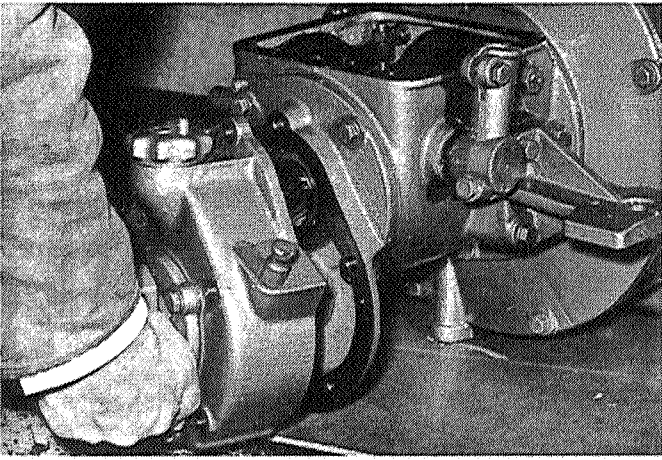

68

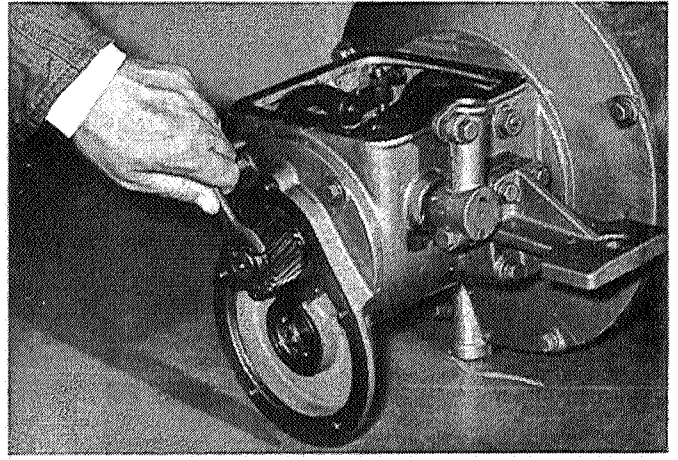

69

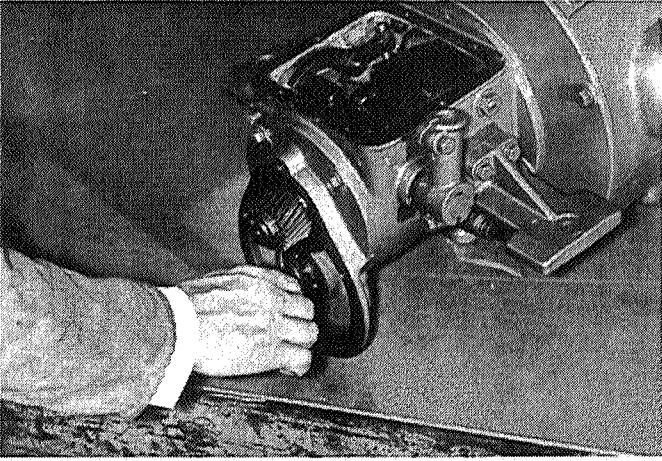

70

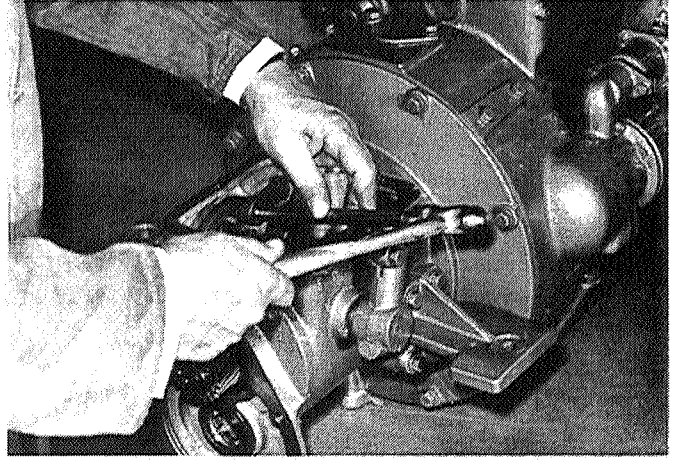

71

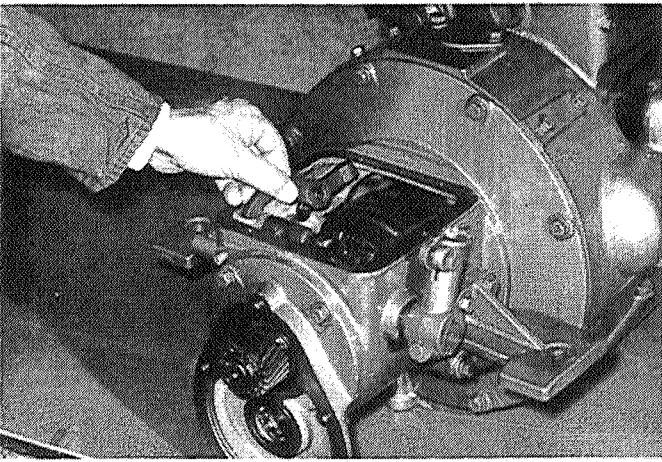

72

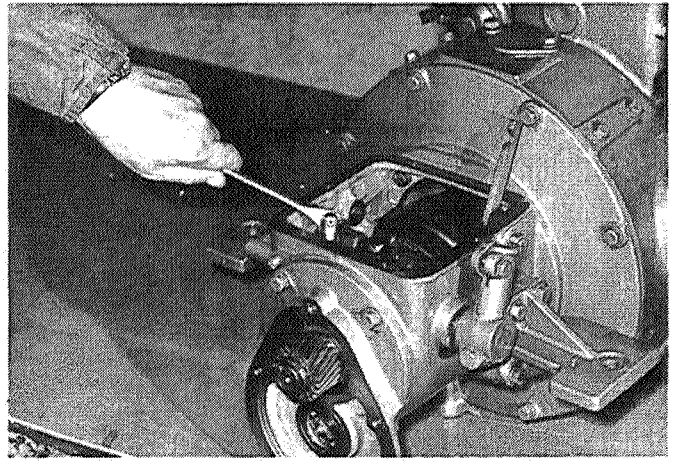

73

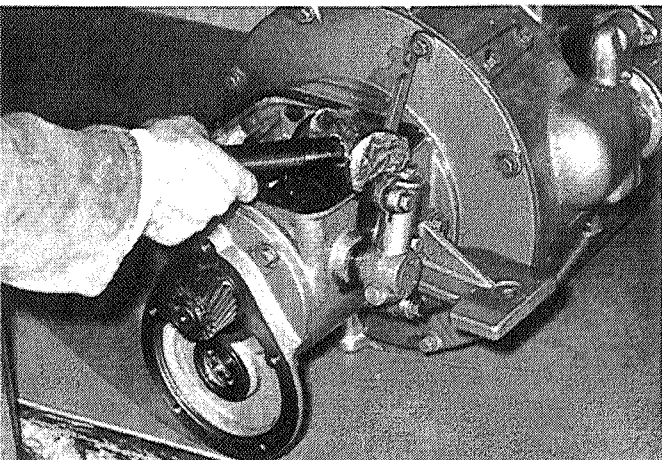

74

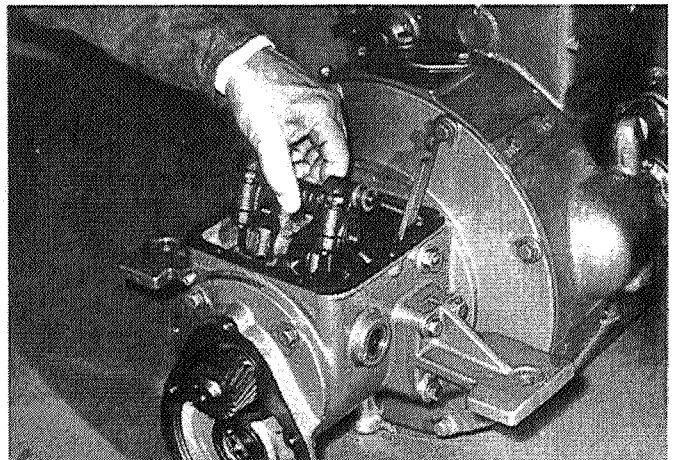

75

Reverse gear and reduction gear (cont.)

99. Release the bolts holding the intermediate section of the gear housing (Fig. 76).
10. Remove the intermediate section of the gear housing together with reverse gear shaft and planetary gear casing (Fig. 77).
11. Remove the snap ring locking the ball bearing in the intermediate section of the gear housing (Fig. 78).
12. Remove the intermediate section of the gear housing together with roller bearings and gears.
Use a puller brace for this operation (Fig. 79).
Special tool: Puller brace V3-41998.
13. Removal can now be carried out with standard pullers (Fig. 80).
14. Remove the lock bolt in the adjusting ring (Fig. 81).
15. Unscrew and remove the adjusting ring (Fig. 82).

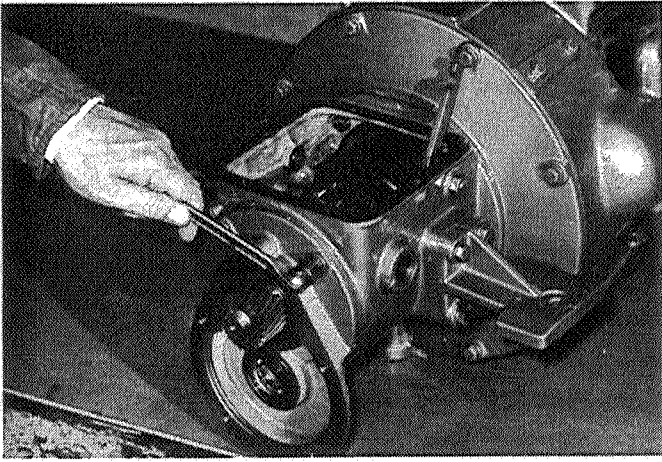

76

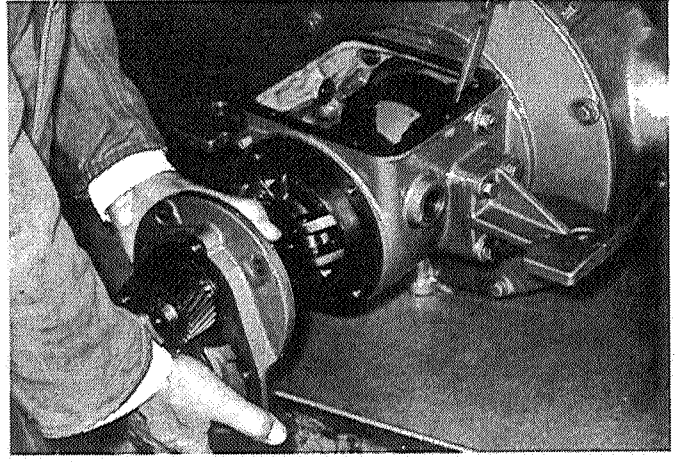

77

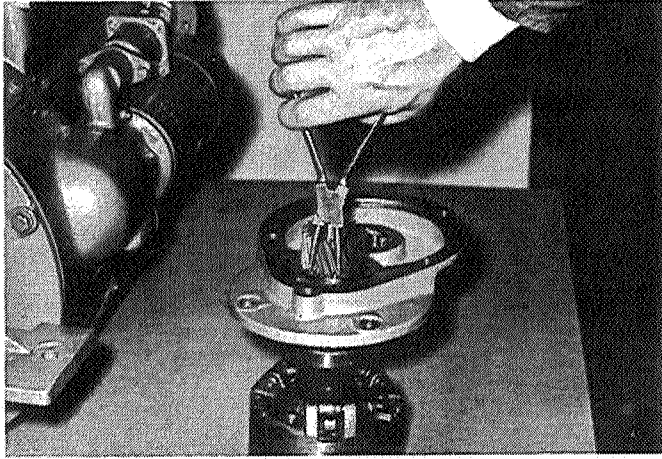

78



79

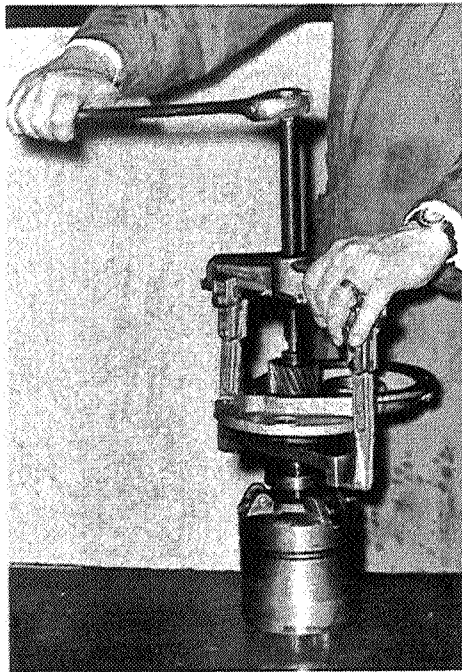

80

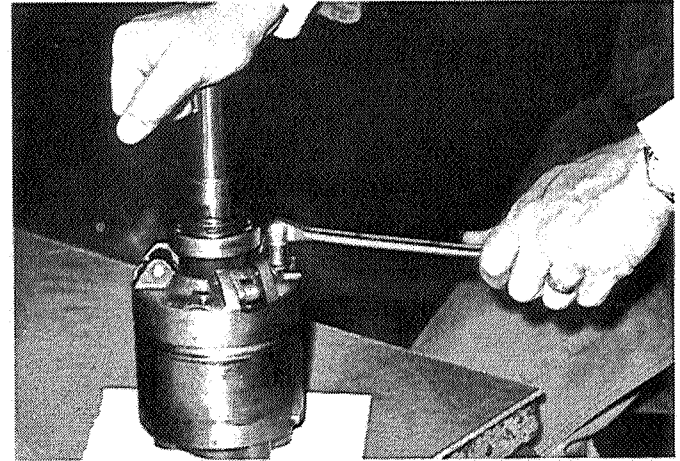

81



82

Reverse gear and reduction gear (cont.)

16. Remove the thrust plate and discs (Fig. 83).
17. Remove the snap ring locking the ball bearing in the planetary gear casing (Fig. 84).
18. Remove the reverse gear shaft with gear from the planetary gear casing (Fig. 85).
19. Remove the retaining ring holding the gears and the ball bearing on the reverse gear shaft (Fig. 86).
20. Press the reverse gear shaft out of both the gears (Fig. 87).
21. Remove the shafts for the planetary gears (Fig. 88).
22. Remove the planetary gears and spacer (Fig. 89).

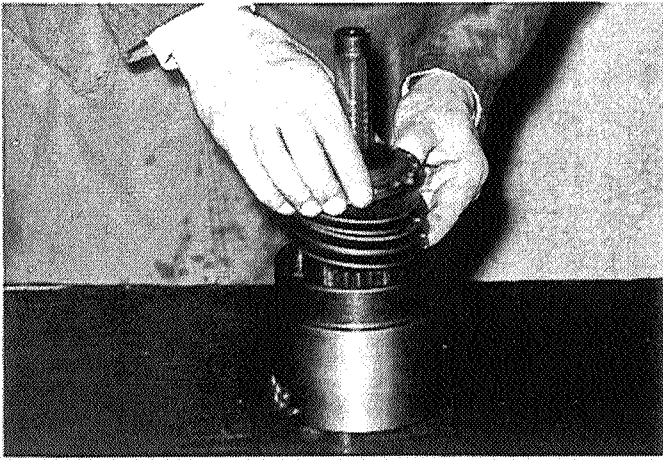

83

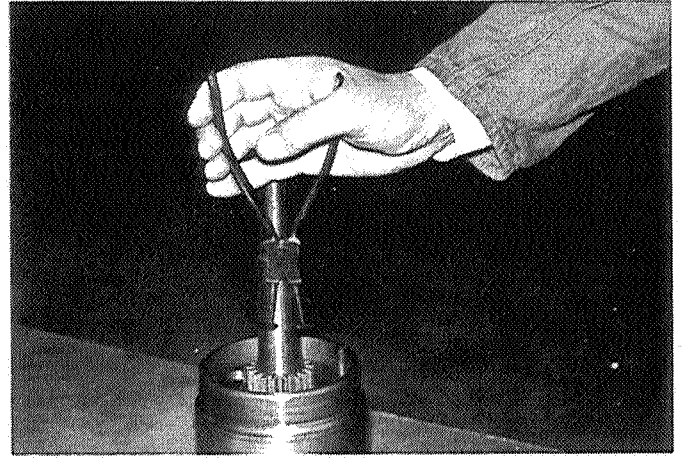

84

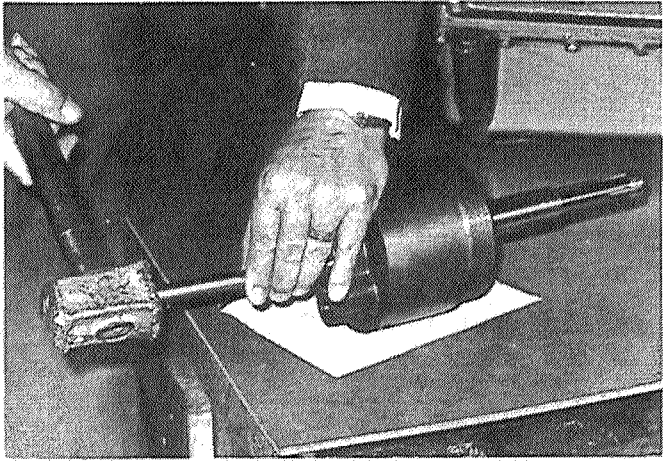

85

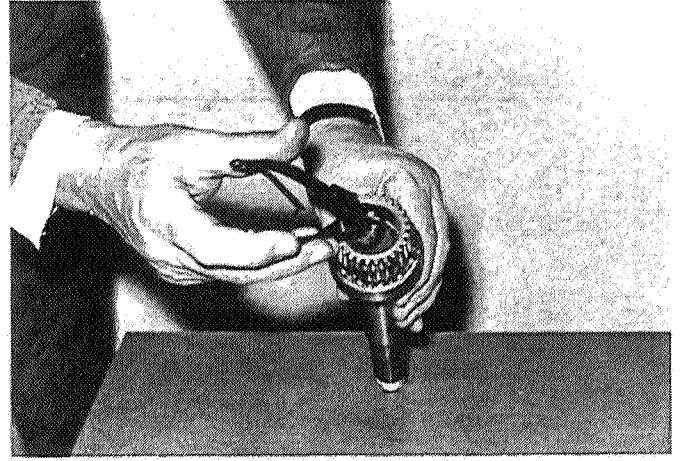

86

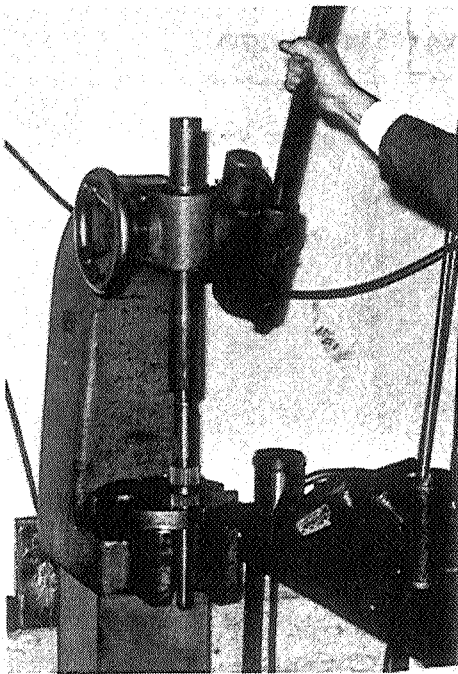

87

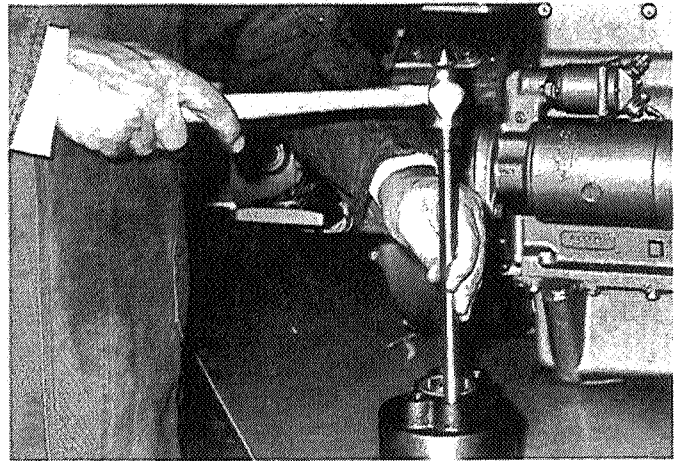

88

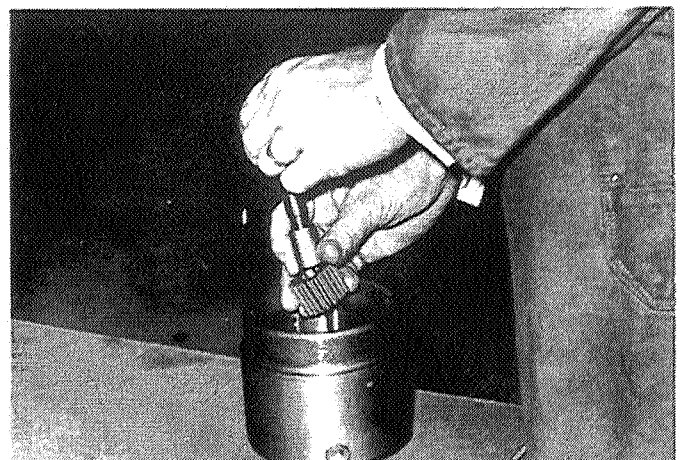

89

Reverse gear and reduction gear (cont.)

23. Remove the large planetary gears (Fig. 90).
24. When removing and fitting the bush in the gear housing, use the special drift (Fig. 91). Special tool, Drift V4-41999.
25. When removing the brake band, first remove the lock screw (Fig. 92).
26. Turn the brake band until its tabs release from the reverse gear casing slots (Fig. 93).
27. Remove the brake band (Fig. 94).
28. Remove the bolts securing the reverse gear casing, which can then be taken off (Fig. 95).
29. Remove the bolts holding the intermediate section, which can then be taken off (Fig. 96).

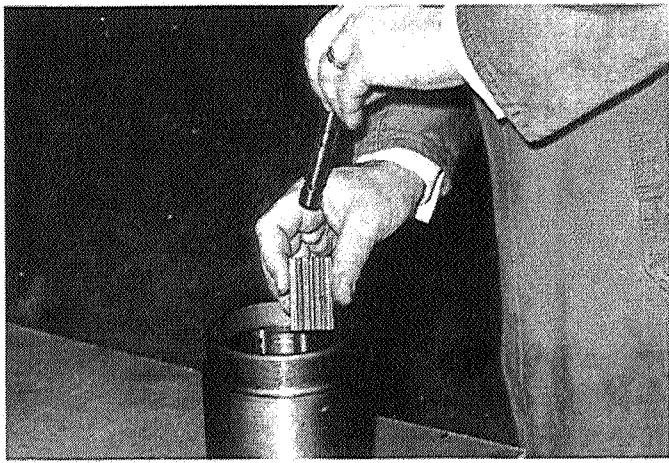

90

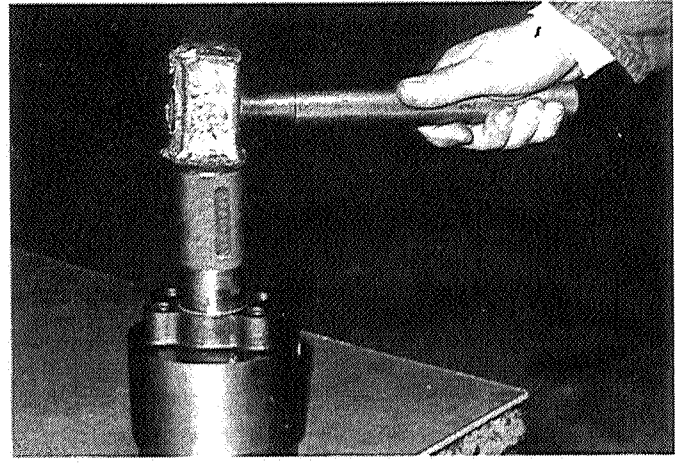

91

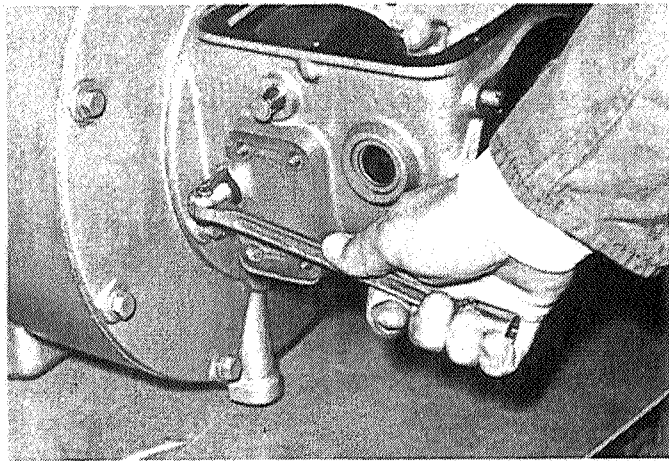

92

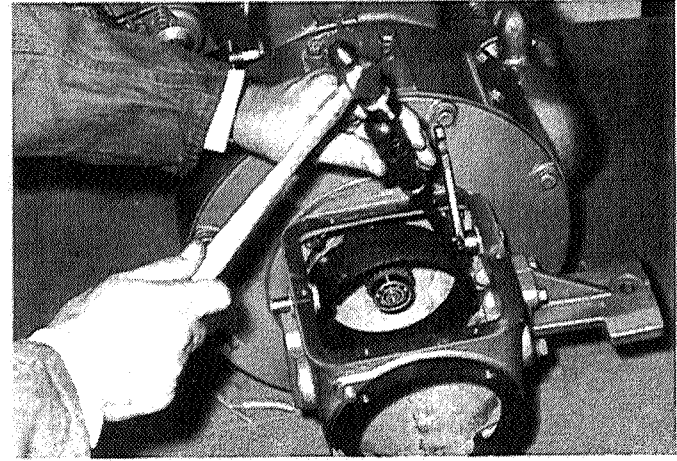

93

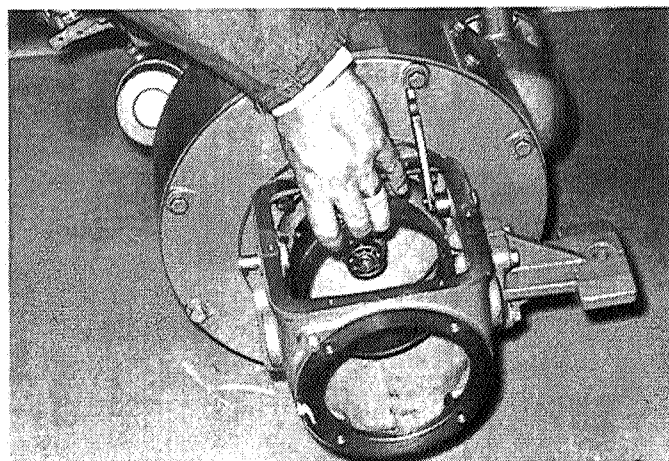

94

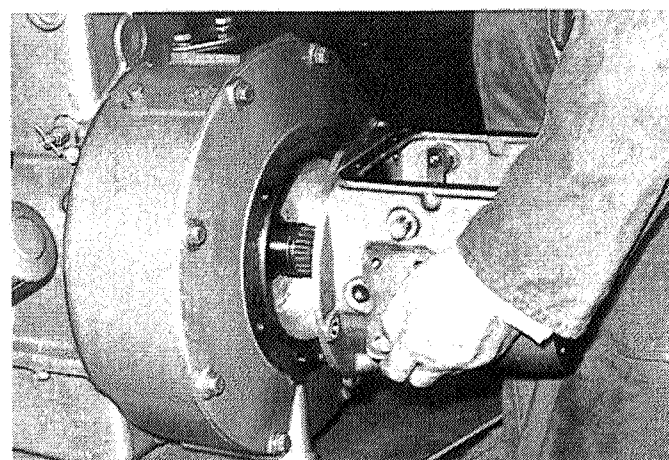

95

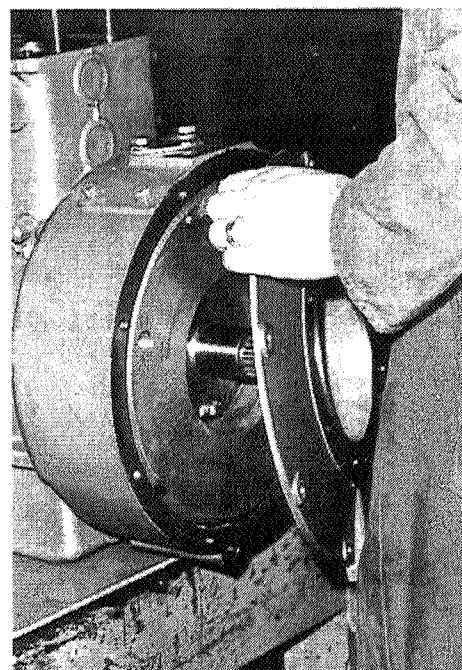

96

Reverse gear and reduction gear (cont.)

30. When fitting the intermediate section, the O-ring at the oil channel should be replaced (Fig. 97).
31. Remove the bolts holding the driving gear with shaft. Remove shaft and driving gear (Fig. 98).
32. Remove the oil pipe from the shaft (Fig. 99).
33. Check to make sure that the oil hole is not blocked (Fig. 100). Replace O-rings before fitting.
34. Release the bolts for the flywheel and remove the flywheel (Fig. 101).
35. After the reverse gear and reduction gear have been re-fitted on the engine (fitting is in reverse order to removal), adjust the reverse gear while running the engine (Fig. 102).

Adjusting for operation "Ahead"

The reverse gear is engaged for operation "Ahead" by slackening the lock bolt 3, and turning the adjusting ring 2 clockwise until the reverse gear stops slipping. Turn the ring further until the lock bolt takes up the first position after the previous one. Then tighten the lock bolt.

36. Adjusting for operation "Astern"

Slacken the locknut on the adjusting bolt. Turn the bolt clockwise until normal engagement is obtained (Fig. 103).

37. Adjusting "Neutral"

Slacken the locknut. Let the engine idle with the operating gear lever in neutral. Turn the bolt anti- or clockwise until the propeller shaft stops rotating (Fig. 104). Tighten the locknut. Adjustment should be carried out with the engine thoroughly warm.

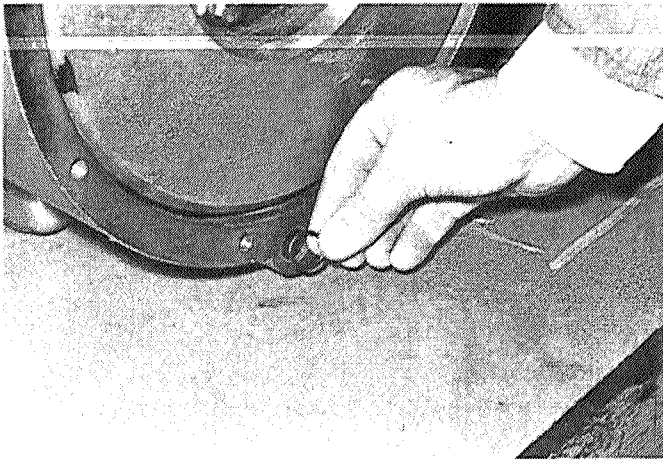

97

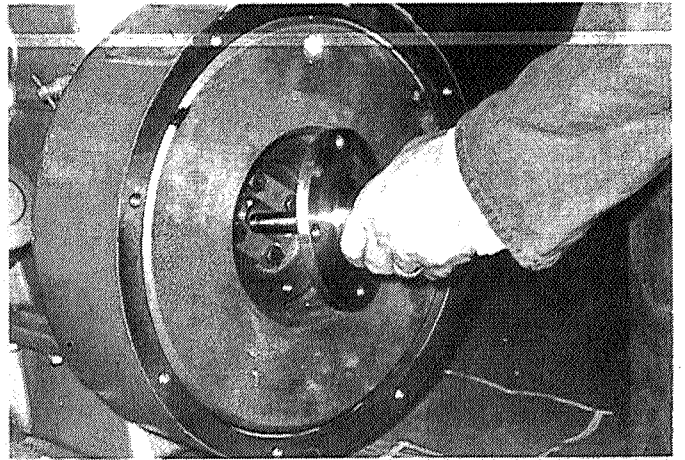

98

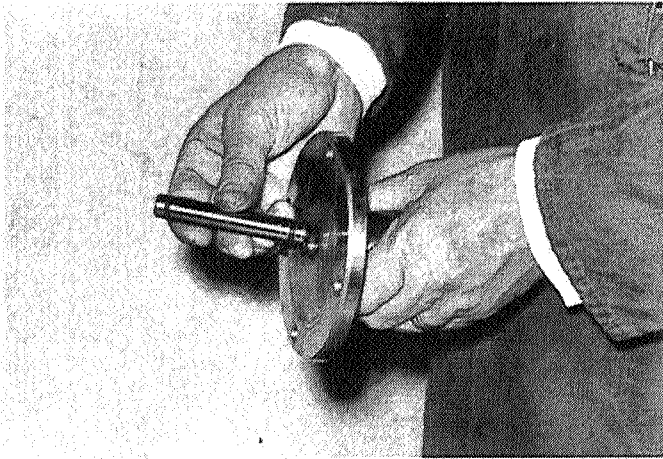

99

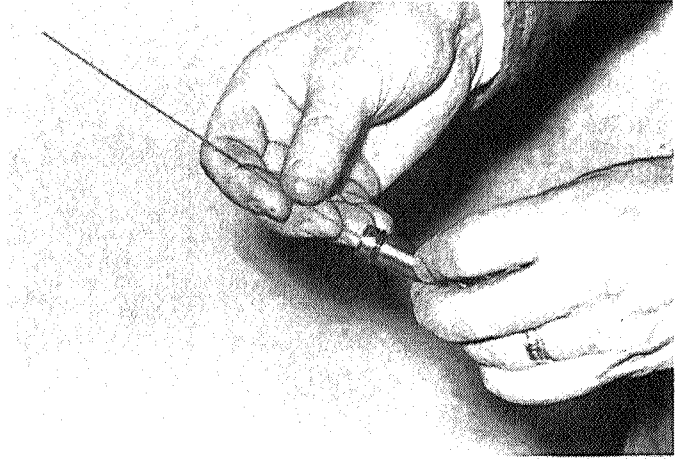

100

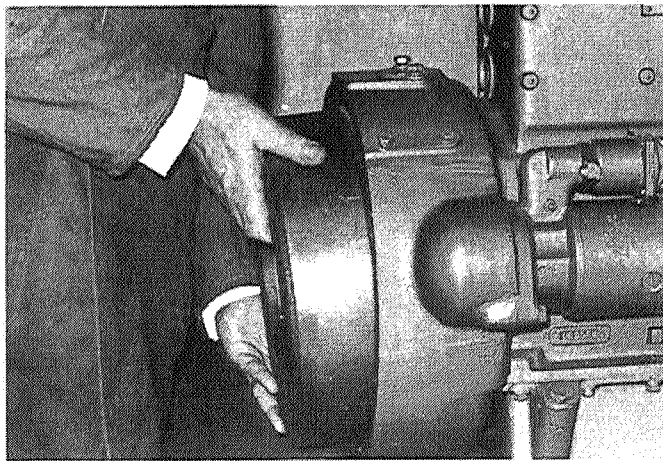

101

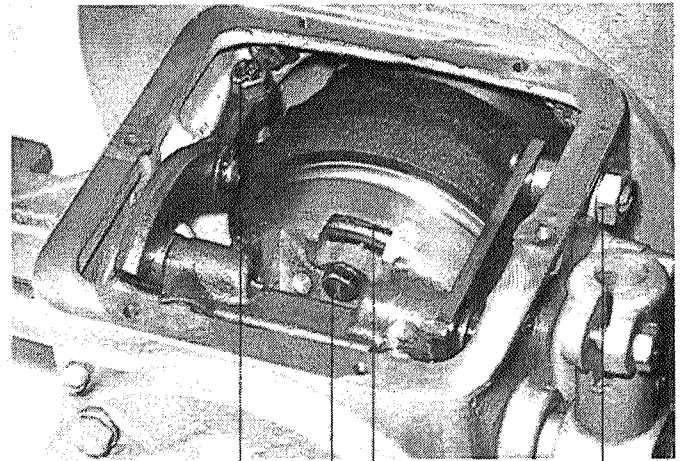

102

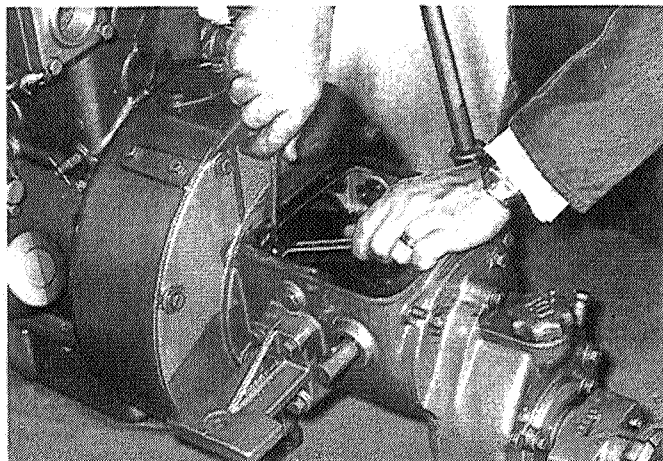

103

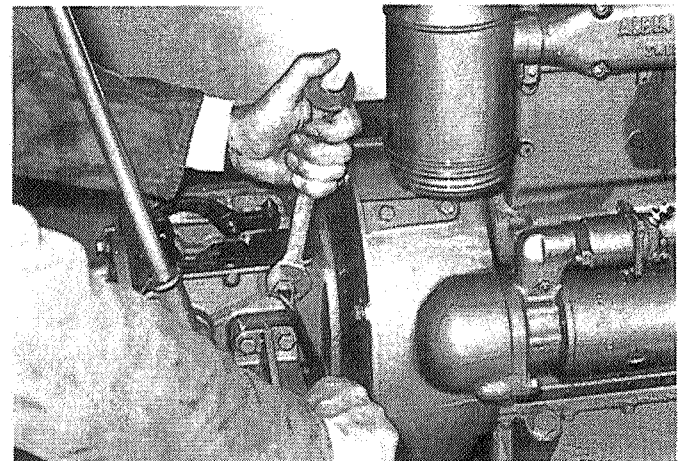

104